



## COMPLEMENTOS

En Complementos hemos reunido a los indispensables: columpios para uno o varios usuarios, columpios tradicionales o adaptados a niños con diversidad funcional; carruseles, espirales; toboganes especiales y terraplenes... Esos elementos sin los que ningún espacio infantil puede considerarse completo. Por eso nuestros Complementos están pensados para combinar de manera armoniosa con todo tipo de entornos y con el resto de elementos del catálogo de Galopín.

En algunos casos pueden reforzar el carácter te-

mático de un parque, ya que ofrecemos también fachaditas tematizadas. En otros, actúan como elementos de transición entre zonas de juego de diferentes características. Por su variedad y tamaño se convierten en la solución perfecta para poner en valor chaflanes, espacios reducidos o zonas que no admiten la instalación de elementos más complejos.

La gama Complementos representa un ejercicio continuo de creatividad y diseño de nuestro equipo, que busca siempre nuevos modos de interpretar algunas de las formas clásicas del juego infantil de todos los tiempos.



**FR**  
Dans la gamme Complementos nous avons réuni les indispensables : balançoires pour un ou plusieurs utilisateurs, balançoires traditionnelles ou adaptées aux enfants à la diversité fonctionnelle, carrousels, spirales, toboggans spéciaux et de butte... Des éléments sans lesquels aucun espace pour enfants ne peut être considéré comme complet. C'est pour ça que nos accessoires ont été conçus pour s'intégrer harmonieusement dans tous types d'environnements et avec l'ensemble du catalogue de Galopín.

Dans certains cas, ils peuvent renforcer le caractère thématique d'un parc, puisque nous proposons également des façades à thème. Dans d'autres, ils agissent comme des éléments de transition entre des zones de jeu de caractéristiques différentes. En raison de leur variété et de leur taille, ils sont la solution parfaite pour mettre en avant de petits espaces ou des zones qui ne permettent pas l'installation d'éléments plus complexes.

La gamme Complementos représente un exercice continu de créativité et de design de nos équipes, qui sont toujours à la recherche de nouvelles façons d'interpréter certaines des formes classiques des jeux de tous les temps.

**EN**

In Complementos, we have grouped together all those accessories that are essential: swings for one or several users, traditional or adapted to children with functional diversity; carousels, spirals; embankment & other special types of slides... All those elements whose absence in a space dedicated to children would make it incomplete. That's why our accessories are designed to harmoniously combine with all types of environments as well as with the rest of the products in Galopín's catalogue.

In some cases, they can help reinforce the central theme of a playground, since we also offer themed play panels. In others, they act as transition elements between the various play areas having different characteristics. Due to their variety and size, they are the perfect solution for small spaces or areas that do not allow the installation of more complex elements.

The range Complementos illustrates the continuous brainstorm of creative design ideas of our team, who is constantly looking for new ways to reinterpret some of the most classical children's games of all time.





**CDE32**

117 m<sup>2</sup>
 50 x 100 cm
 100 cm
 1 u.
 +2



**L41**

18,7 m<sup>2</sup>
 79 x 79 cm
 100 cm
 4 u.
 +2



**L21**

23,9 m<sup>2</sup>
 152 x 152 cm
 100 cm
 4 u.
 +4



**L50**

25,8 m<sup>2</sup>
 210 x 210 cm
 100 cm
 6 u.
 +4



**L25**

23,9 m<sup>2</sup>
 152 x 152 cm
 100 cm
 4 u.
 +4

**L70**

20,1 m<sup>2</sup>
 108 x 108 cm
 100 cm
 1 u.
 +4





L75

24,1 m<sup>2</sup>
 154 x 154 cm
 100 cm
 1 u.
 +4



L85i

27 m<sup>2</sup>
 270 x 270 cm
 100 cm
 4 u.
 +4

L80

29,2 m<sup>2</sup>
 210 x 210 cm
 100 cm
 5 u.
 +4



L90

50,2 m<sup>2</sup>
 100 x 100 cm
 100 cm
 4 u.
 +4

ML100

18,1 m<sup>2</sup>
 80 x 80 cm
 100 cm
 8 u.
 +4



L82i

27 m<sup>2</sup>
 230 x 230 cm
 100 cm
 4 u.
 +4

ML110

8,6 m<sup>2</sup>
 48 x 46 cm
 100 cm
 1 u.
 +4



**ML902**

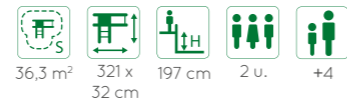

**ML903**

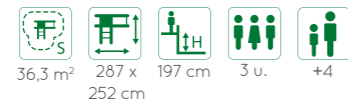

**ML904**

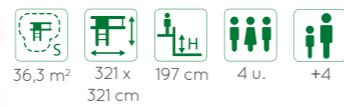



50025

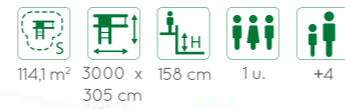

Consultar longitudes disponibles.  
Check available lengths.  
Vérifiez les longueurs disponibles.

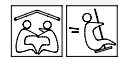

50023

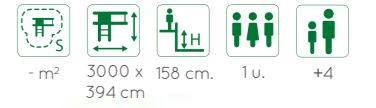

Consultar longitudes disponibles.  
Check available lengths.  
Vérifiez les longueurs disponibles.



50026

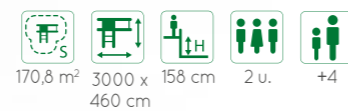

Consultar longitudes disponibles.  
Check available lengths.  
Vérifiez les longueurs disponibles.

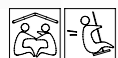



50010

- m<sup>2</sup>
 3000 x 158 cm
 305 cm
 1 u.
 +4

Consultar longitudes disponibles.  
 Check available lengths.  
 Vérifiez les longueurs disponibles.

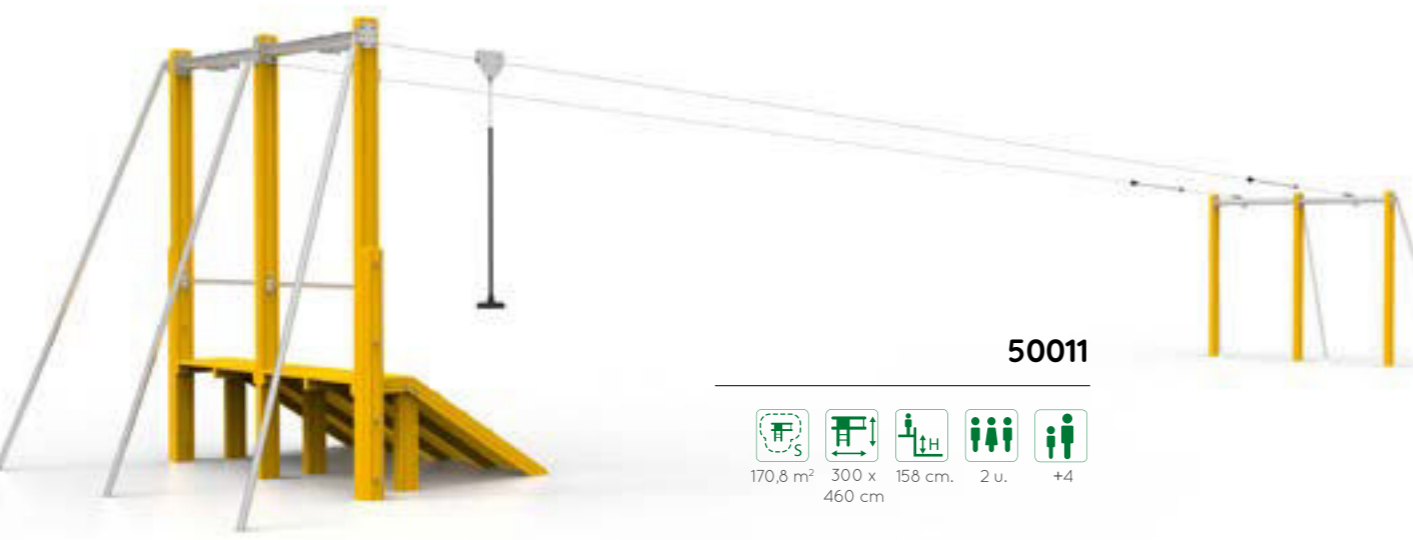
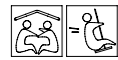

50011

170,8 m<sup>2</sup>
 300 x 158 cm.
 460 cm.
 2 u.
 +4

Consultar longitudes disponibles.  
 Check available lengths.  
 Vérifiez les longueurs disponibles.

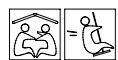

50027

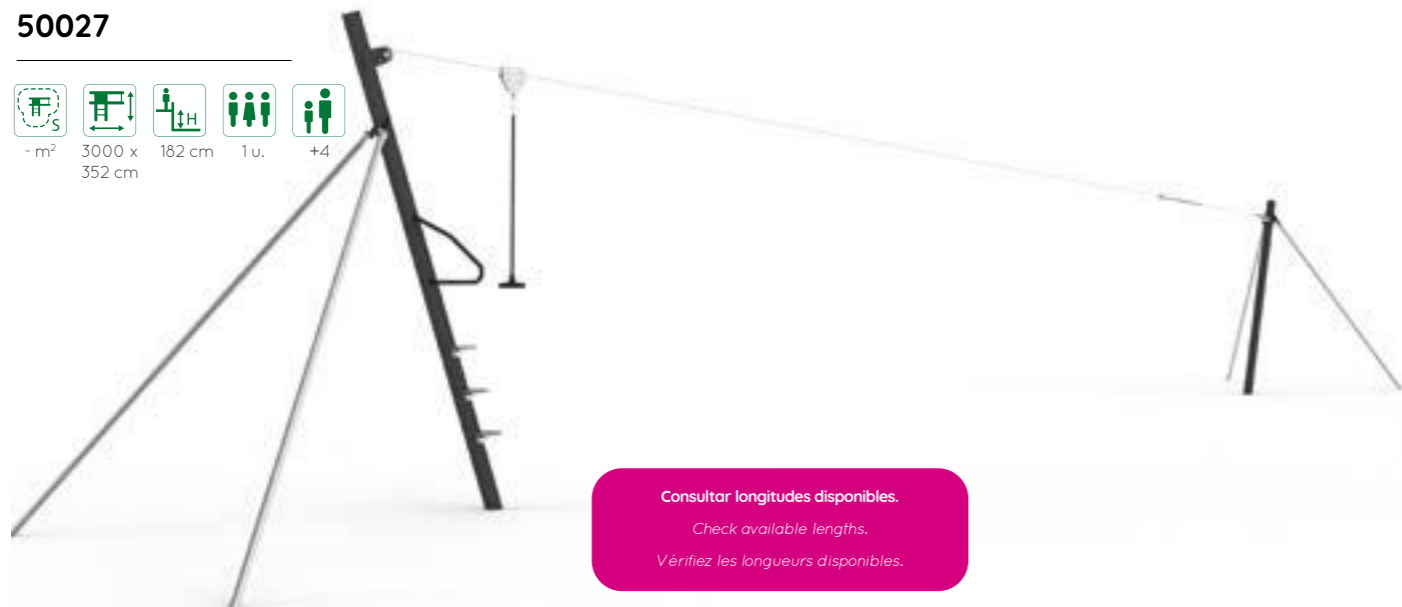
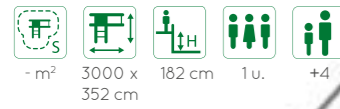

Consultar longitudes disponibles.  
Check available lengths.  
Vérifiez les longueurs disponibles.

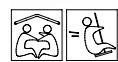

TR100

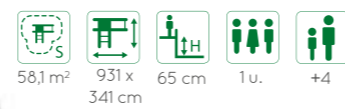

Consultar longitudes disponibles.  
Check available lengths.  
Vérifiez les longueurs disponibles.

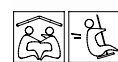

FAC02-c2

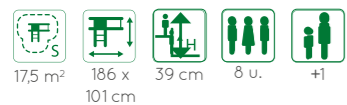

FAC02-c1



DIN33942



FAC03-c2

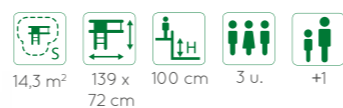

FAC03-c1



DIN33942

FAC04

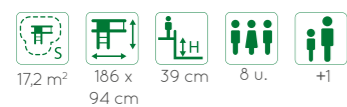

DIN33942







FAC05

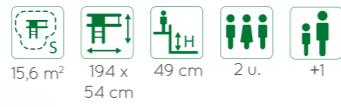

FAC06

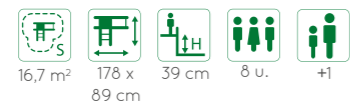

DIN33942

FAC07

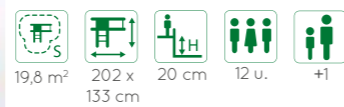

DIN33942





FAC08T\_P

12,8 m<sup>2</sup> 83 x 41 cm 2 u. +1



FAC13

18,2 m<sup>2</sup> 156 x 40 cm 12 u. +1



FAC09T\_P

14,3 m<sup>2</sup> 125 x 23 cm 2 u. +1

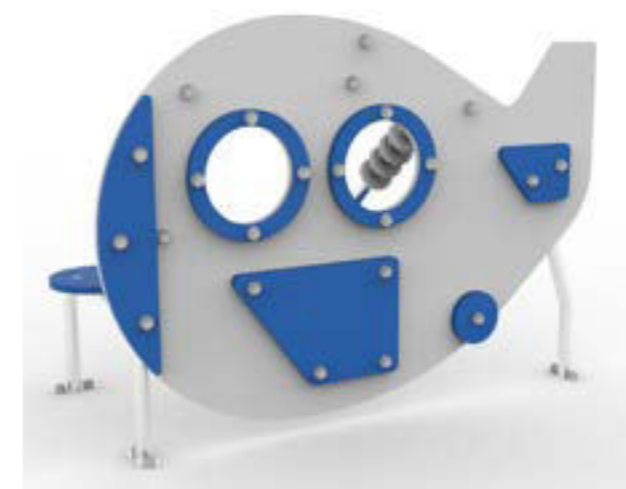
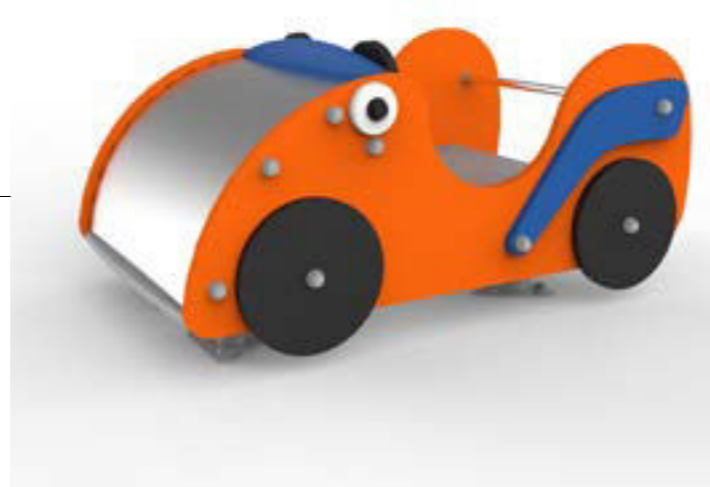

FAC14

14,4 m<sup>2</sup> 152 x 39 cm 8 u. +1



FAC12

17,6 m<sup>2</sup> 148 x 50 cm 12 u. +1

FAC15

16 m<sup>2</sup> 151 x 39 cm 8 u. +1





FAC19

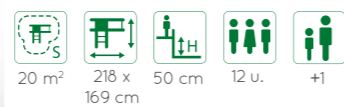

FAC20

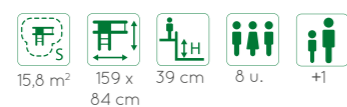

DIN33942

FAC21

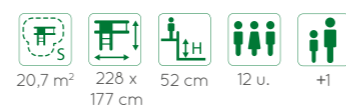



FAC22

16,2 m<sup>2</sup> 166 x 142 cm 4 u. +1



DIN33942

FAC23T\_P

18,2 m<sup>2</sup> 184 x 40 cm 12 u. +1

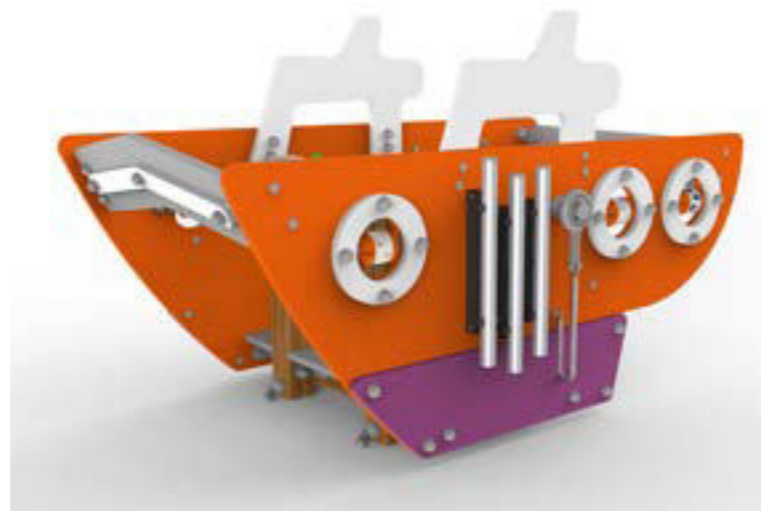

DIN33942



FAC24

16,6 m<sup>2</sup> 178 x 39 cm 8 u. +1



DIN33942



FAC26

16,8 m<sup>2</sup> 188 x 39 cm 8 u. +1



DIN33942

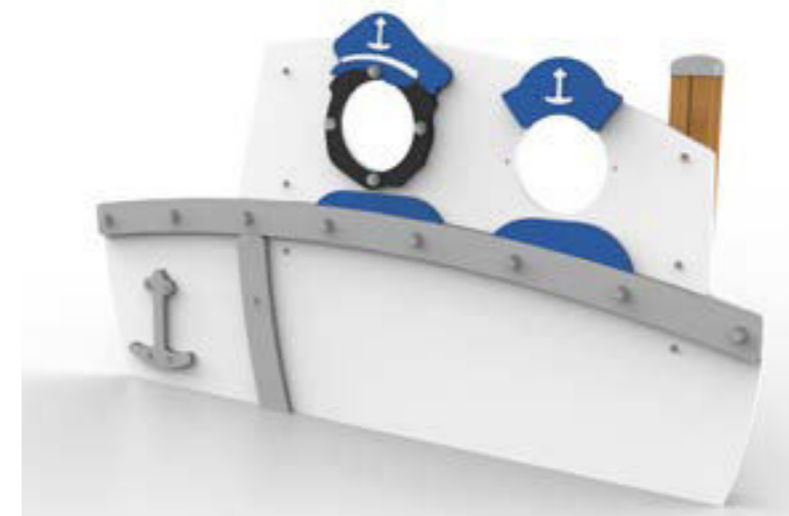

DIN33942

FAC100

15,4 m<sup>2</sup> 206 x 39 cm 3 u. +2

FAC100AL



PEZ01

25,8 m<sup>2</sup> 253 x - cm 8 u. +1





U50A\_P

7,6 m<sup>2</sup> 85 x 48 cm 60 cm 1 u. +2



U80A\_P

7,5 m<sup>2</sup> 77 x 48 cm 60 cm 1 u. +2



U60Ai\_P

7,6 m<sup>2</sup> 85 x 50 cm 60 cm 1 u. +2



DIN33942



U60A\_P

7,6 m<sup>2</sup> 85 x 48 cm 60 cm 1 u. +2



B102Ai

7,6 m<sup>2</sup> 83 x 50 cm 60 cm 1 u. +2



DIN33942



B102A

7,6 m<sup>2</sup> 83 x 44 cm 60 cm 1 u. +2



B104A

7 m<sup>2</sup> 86 x 26 cm 60 cm 1 u. +2

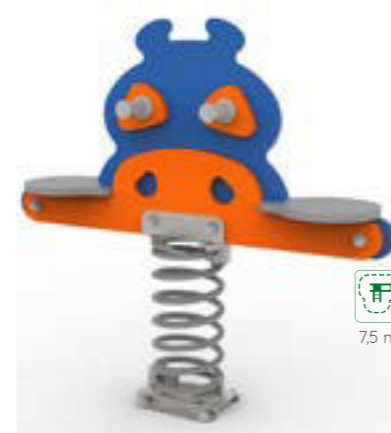

B101A

7,5 m<sup>2</sup> 112 x 26 cm 81 cm 2 u. +2

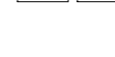

B30C\_P

9,7 m<sup>2</sup> 101 x 93 cm 60 cm 2 u. +2



B140B

12,6 m<sup>2</sup> 331 x 28 cm 100 cm 4 u. +2

B140B\_AL



B30B\_P

13,4 m<sup>2</sup> 331 x 28 cm 100 cm 2 u. +2

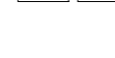

B30B\_PAL



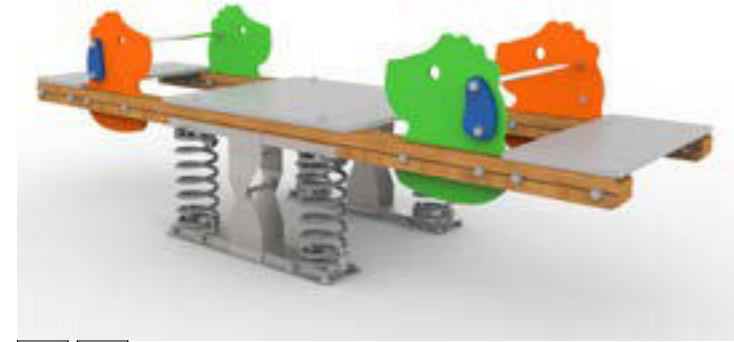

**B30E\_P**  
 21,5 m<sup>2</sup> 320 x 99 cm. 4 u. +2



**U100A\_P-c2**

8,6 m<sup>2</sup> 156 x 94 cm 2 u. +2



**B110A\_P**  
 14 m<sup>2</sup> 190 x 79 cm 4 u. +2



**B40B\_P**

13,2 m<sup>2</sup> 220 x 100 cm 4 u. +2



**U10A\_P**  
 9,4 m<sup>2</sup> 96 x 60 cm 1 u. +2



**U40A\_P**  
 7,4 m<sup>2</sup> 103 x 64 cm 1 u. +2



**B50A\_P**  
 90 m<sup>2</sup> 84 x 60 cm 2 u. +2



**B60D\_P**  
 10 m<sup>2</sup> 111 x 60 cm 2 u. +2



**B60A\_P**  
 10,1 m<sup>2</sup> 120 x 60 cm 2 u. +2



**B60Ai\_P**  
 10,4 m<sup>2</sup> 120 x 60 cm 2 u. +2



**U120Ai**

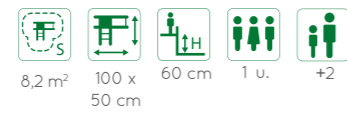

DIN33942

**U130Ai**

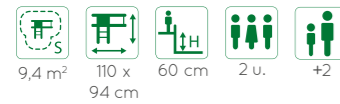

DIN33942

**U20A\_P**

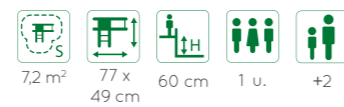

**B103A**

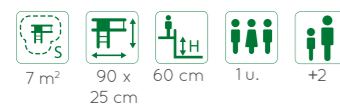

**B20A**

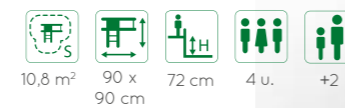

**B90A\_P**

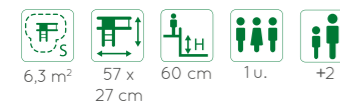

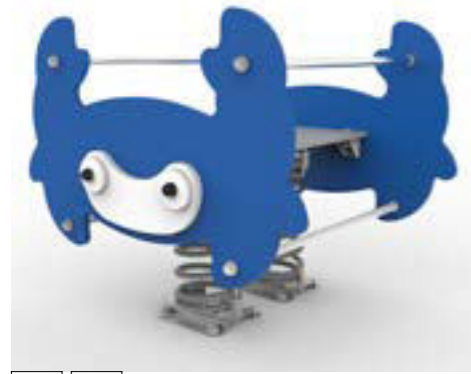

**B35A**

9,8 m<sup>2</sup> 100 x 95 cm 60 cm 2 u. +2



**U90A**

7,7 m<sup>2</sup> 81 x 48 cm 60 cm 1 u. +2

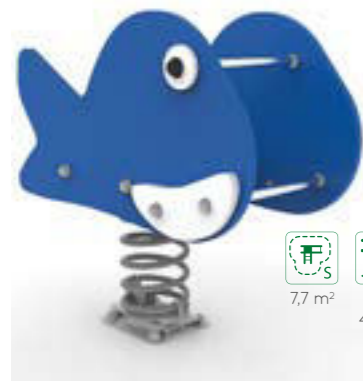

**U30A\_P**

7,7 m<sup>2</sup> 91 x 48 cm 60 cm 1 u. +2



**U30Ai\_P**

7,4 m<sup>2</sup> 91 x 50 cm 60 cm 1 u. +2

DIN33942



**PLA003**

7,2 m<sup>2</sup> 96 x 26 cm 60 cm 1 u. +2





**PLA009**

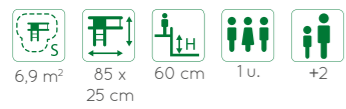

**B90E**

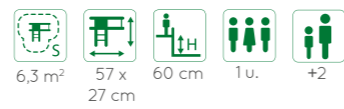

**B300E-c2**

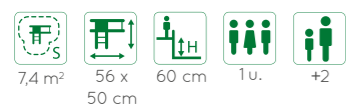

**B300E-c1**



**U110A**

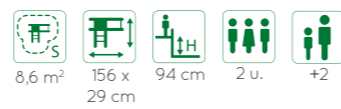



**A10-IN**

14,1 m<sup>2</sup>
 178 x 40 cm
 66 cm
 2 u.
 +4

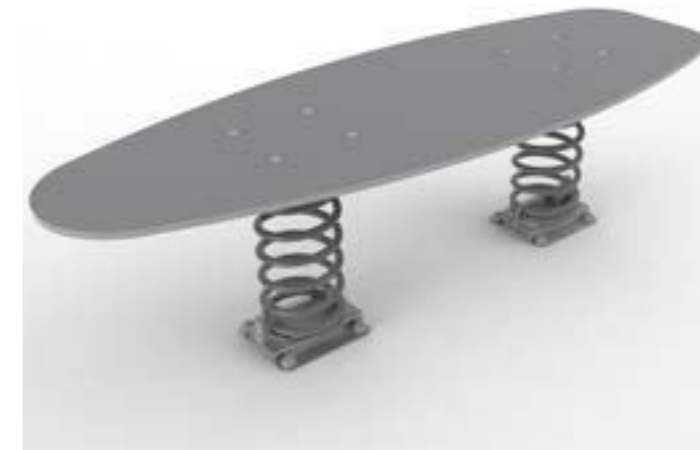

**B130A**

15,8 m<sup>2</sup>
 184 x 66 cm
 60 cm
 1 u.
 +6





**TGM1**  
 16,2 m<sup>2</sup> 208 x 108 cm 60 cm 2u. +6



**TGM2**  
 12,4 m<sup>2</sup> 78 x 78 cm 60 cm 1u. +6



**TGM3**  
 13,3 m<sup>2</sup> 144 x 76 cm 60 cm 1u. +6



**TGM4**  
 13,3 m<sup>2</sup> 154 x 55 cm 60 cm 1u. +6



**TGM5**  
 11,3 m<sup>2</sup> 99 x 53 cm 60 cm 1u. +6

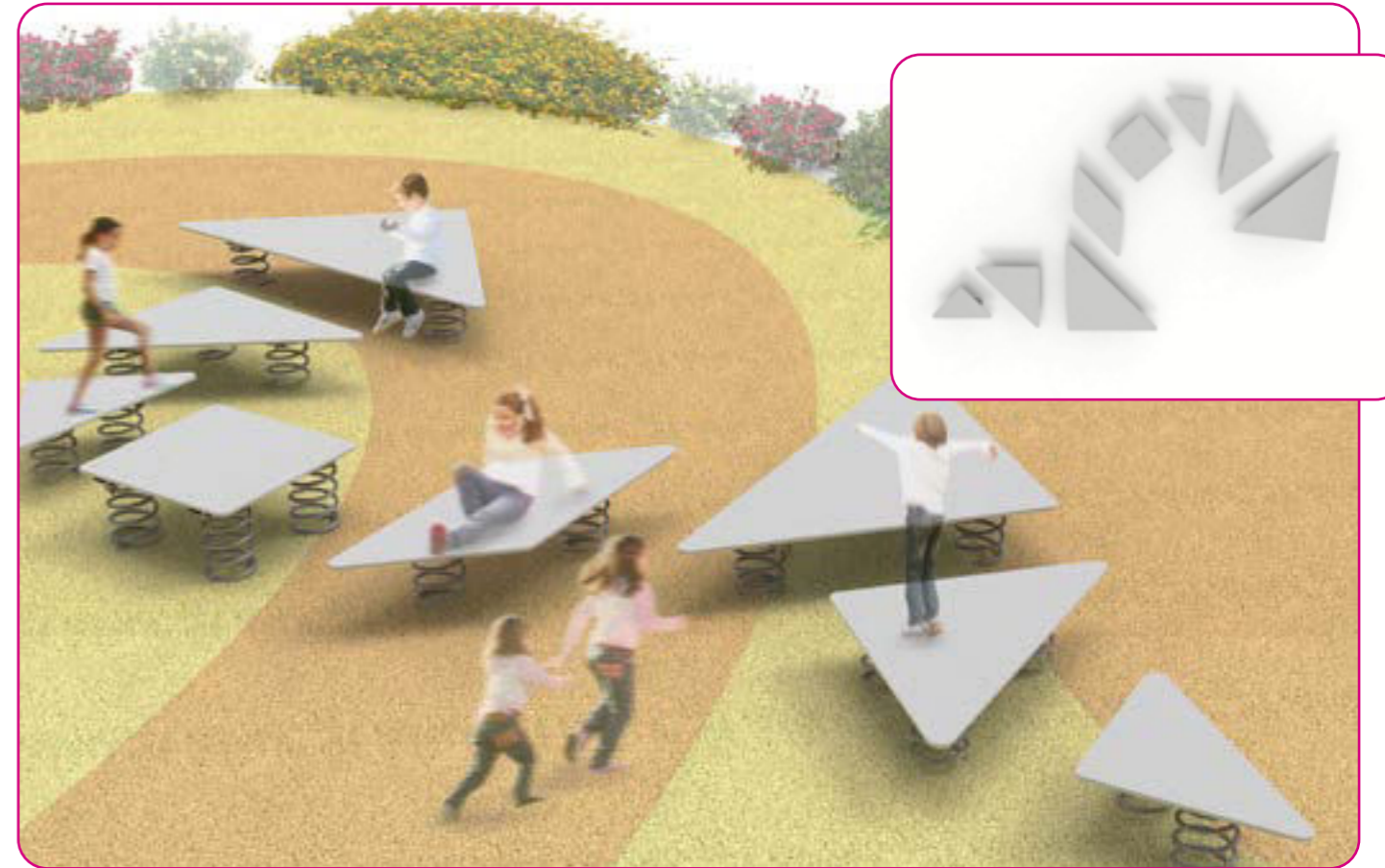

**TOBREC**

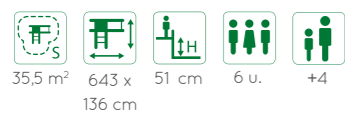

35,5 m<sup>2</sup> 643 x 51 cm 6 u. +4

Consultar otros modelos y dimensiones.

Consult other models and dimensions.

Consulter d'autres modèles et dimensions.



**T1400AB**

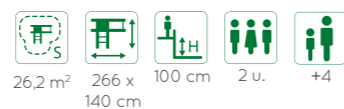

26,2 m<sup>2</sup> 266 x 100 cm 2 u. +4



**T1400A**



DIN33942

**TOB-INOX**

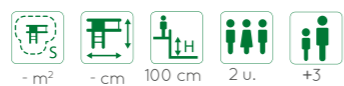

- m<sup>2</sup> - cm 100 cm 2 u. +3

Consultar otros modelos y dimensiones.

Consult other models and dimensions.

Consulter d'autres modèles et dimensions.

ALTURA / HEIGHT / HAUTEUR

0,6 m

1 m

1,4 m

1,85 m

3 m

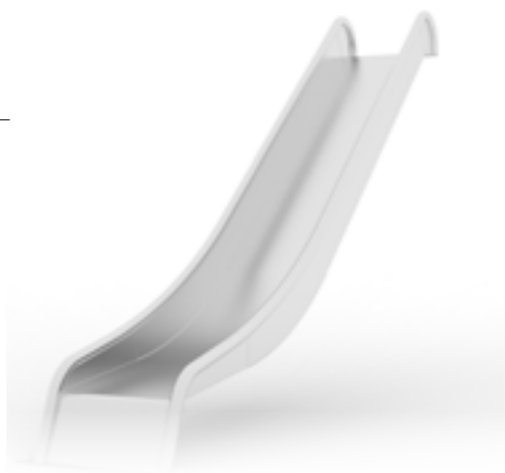



TTI\_3,25

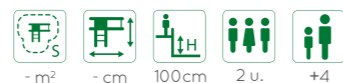

Consultar otros modelos y dimensiones.  
Consult other models and dimensions.  
Consulter d'autres modèles et dimensions.

TTI\_1,9

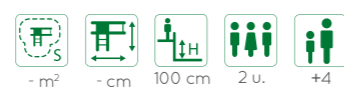

ALTURA / HEIGHT / HAUTEUR  
3,25 m  
1,9 m

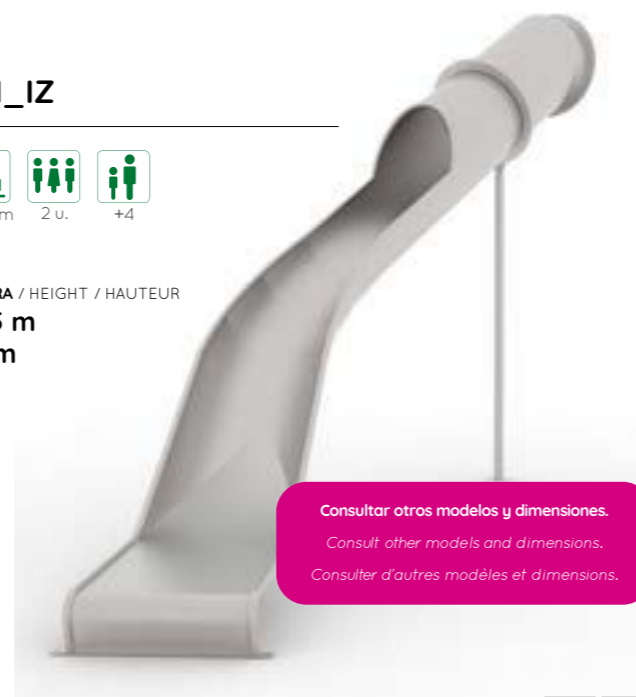

Consultar otros modelos y dimensiones.  
Consult other models and dimensions.  
Consulter d'autres modèles et dimensions.

TTI\_DE

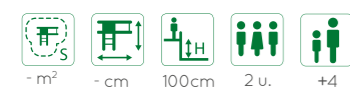

ALTURA / HEIGHT / HAUTEUR  
3,25 m  
1,9 m



Consultar otros modelos y dimensiones.  
Consult other models and dimensions.  
Consulter d'autres modèles et dimensions.



TIC



ALTURA / HEIGHT / HAUTEUR  
3,25 m  
2,6 m  
1,9 m

Consultar otros modelos y dimensiones.  
Consult other models and dimensions.  
Consulter d'autres modèles et dimensions.

TIC\_1,9



ALTURA / HEIGHT / HAUTEUR  
3,25 m  
2,6 m  
1,9 m



Consultar otros modelos y dimensiones.  
Consult other models and dimensions.  
Consulter d'autres modèles et dimensions.



TIC\_DE

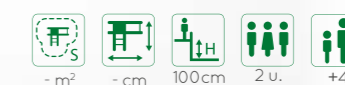

ALTURA / HEIGHT / HAUTEUR  
3,25 m  
2,6 m  
1,9 m



Consultar otros modelos y dimensiones.  
Consult other models and dimensions.  
Consulter d'autres modèles et dimensions.

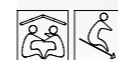

**Toboganes Rectos / Straight slides / Diapositives Droites:**

<b>ROT500</b>	HDPE 500 mm
<b>ROT600</b>	HDPE 600 mm
<b>ROT900</b>	HDPE 900 mm
<b>ROT1000</b>	HDPE 1000 mm
<b>ROT1300</b>	HDPE 1300 mm
<b>ROT1400</b>	HDPE 1400 mm
<b>ROT1700</b>	HDPE 1700 mm
<b>ROT1800</b>	HDPE 1800 mm
<b>ROT2100</b>	HDPE 2100 mm
<b>ROT2200</b>	HDPE 2200 mm
<b>ROT2500</b>	HDPE 2500 mm



**Toboganes Con Una Curva / Slides With A Curve / Diapositives avec une courbe:**

<b>ROT1000-2D</b>	HDPE 1000 2D
<b>ROT1000-2I</b>	HDPE 1000 2I
<b>ROT1400-3D</b>	HDPE 1400 3D
<b>ROT1400-3I</b>	HDPE 1400 3I



**Toboganes con dos curvas / Slides with two curves / Glissières à deux courbes:**

ROT1800-2D4I	HDPE 1800 2D4I
ROT1800-2I4D	HDPE 1800 2I4D
ROT2200-3D5I	HDPE 2200 3D5I
ROT2200-3I5D	HDPE 2200 3I5D
ROT2500-3D5I	HDPE 2500 3D5I
ROT2500-3I5D	HDPE 2500 3I5D
ROT3000-3D6I	HDPE 3000 3D6I
ROT3000-3I6D	HDPE 3000 3I6D
ROT3400-3D6I	HDPE 3400 3D6I
ROT3400-3I6D	HDPE 3400 3I6D
ROT3800-4D7I	HDPE 3800 4D7I
ROT3800-4I7D	HDPE 3800 4I7D
ROT4200-4D8I	HDPE 4200 4D8I
ROT4200-4I8D	HDPE 4200 4I8D

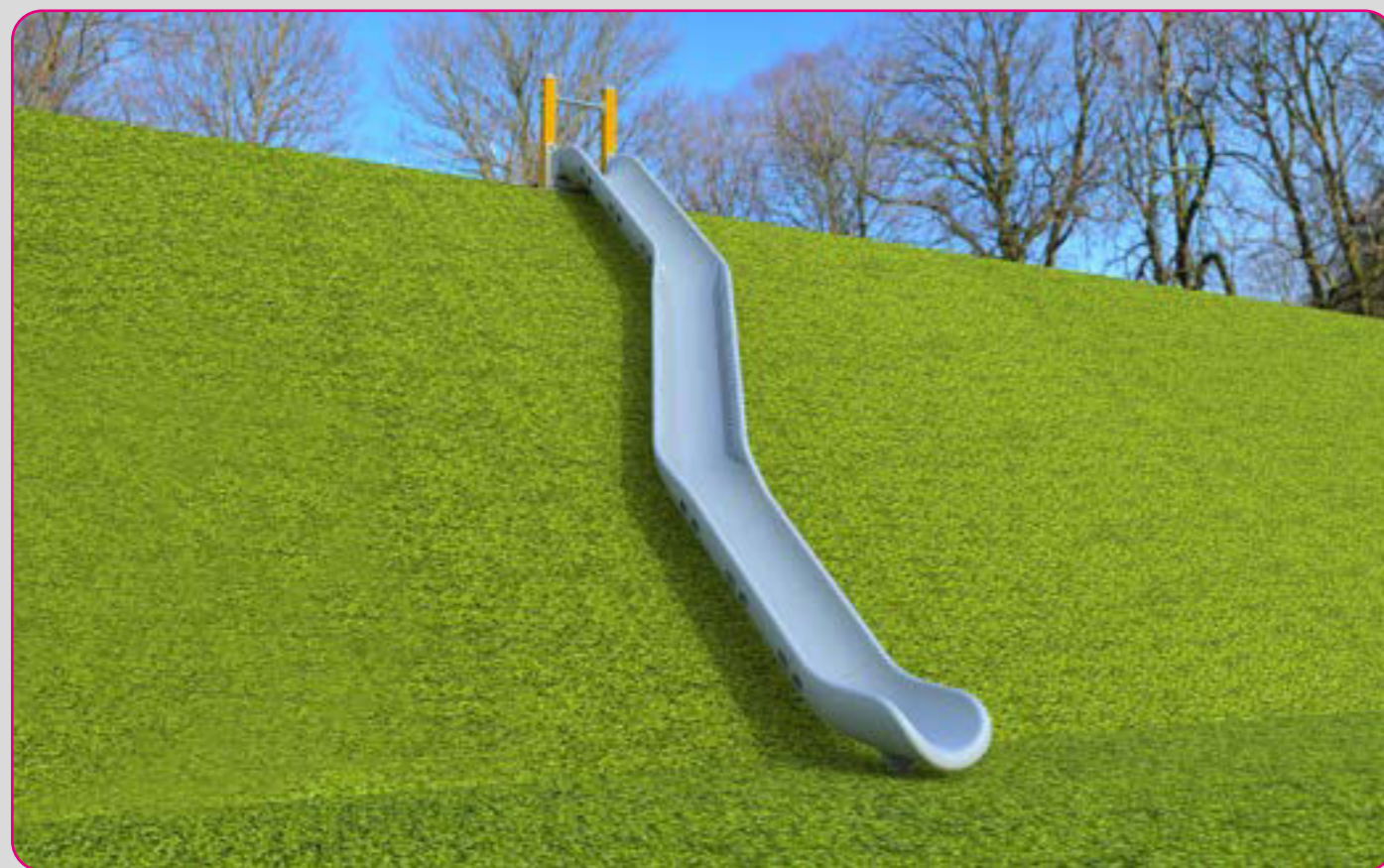

ÁREA DE SALTO / JUMPING AREA / ZONE DE SAUT

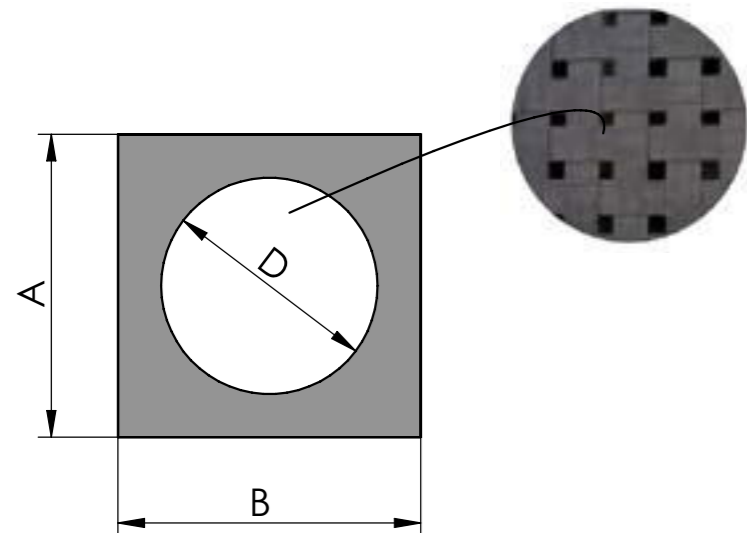

Tejido reforzado con alambre de seis pliegues  
Reinforced fabric with six fold wires  
Tissu renforcé avec fil à six plis

DIMENSIONES / DIMENSIONS / DIMENSIONS			
REF.	A (cm)	B (cm)	D (cm)
1006242	150	150	92
1002457	200	200	143

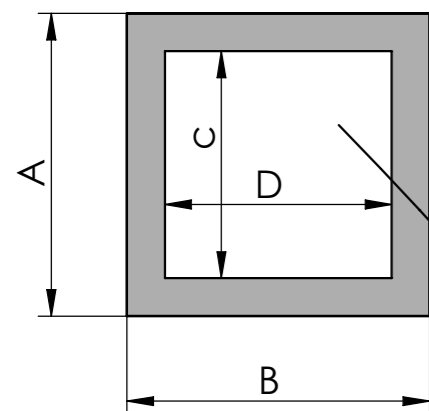

DIMENSIONES / DIMENSIONS / DIMENSIONS				
REF.	A (cm)	B (cm)	C (cm)	D (cm)
1005256	150	150	100	100
1006241	175	150	125	100
1006216	200	200	150	150
1006219	250	250	200	200
1006218	300	225	250	175
1006217	300	200	250	150

ÁREA DE SALTO / JUMPING AREA / ZONE DE SAUT



Eslabones de plástico tensados mediante cable  
Plastic link wire tensioned  
Maillons en plastique tendus per câble

DIMENSIONES / DIMENSIONS / DIMENSIONS		
REF.	A (cm)	D (cm)
1009147	170	120
1006224	240	190

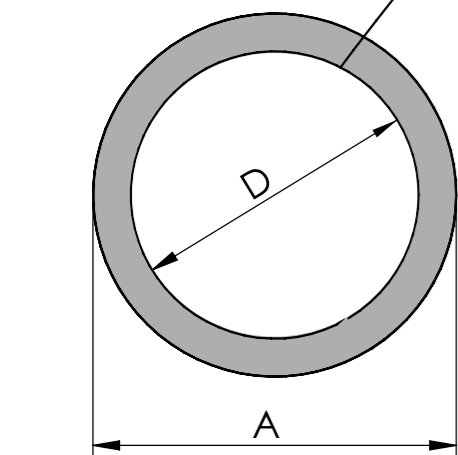





L19

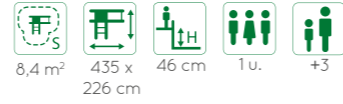

8,4 m<sup>2</sup> 435 x 226 cm 46 cm 1 u. +3



TOB01



- m<sup>2</sup> - cm - cm 12 u. +4

Consultar otros modelos y dimensiones.

Consult other models and dimensions.

Consulter d'autres modèles et dimensions.

DIN33942  





## MOBILIARIO

Como ocurre con el resto de los espacios públicos, parques y zonas de ocio no pueden considerarse completos sin la aportación del Mobiliario. En Galopín nos guiamos por el deseo de llevar al espacio público, esa casa de todos, la sensación de bienestar y confort de la que gozamos en nuestros hogares.

Elementos de señalética, papeleras, paneles informativos, cerramientos... buscamos diseños sencillos, que se integren con el entorno y con el resto de productos de nuestras gamas. Que guíen e informe de manera clara para que los

usuarios de los parques cuenten siempre con los datos o los servicios que necesitan.

Y cuidamos especialmente las mesas, los bancos y los elementos de asiento. Porque los parques no son solo el territorio natural de los niños, sino también de los adultos y los abuelos. Por eso estudiamos las curvas de los respaldos o los ángulos de los asientos con la misma atención con que diseñamos todos nuestros juegos. Un asiento bien diseñado es descanso, hora de la merienda, lugar donde dejar la ropa que sobra durante el juego y recuperamos luego para que no se enfríen. Y es diálogo, tertulia y convivencia.

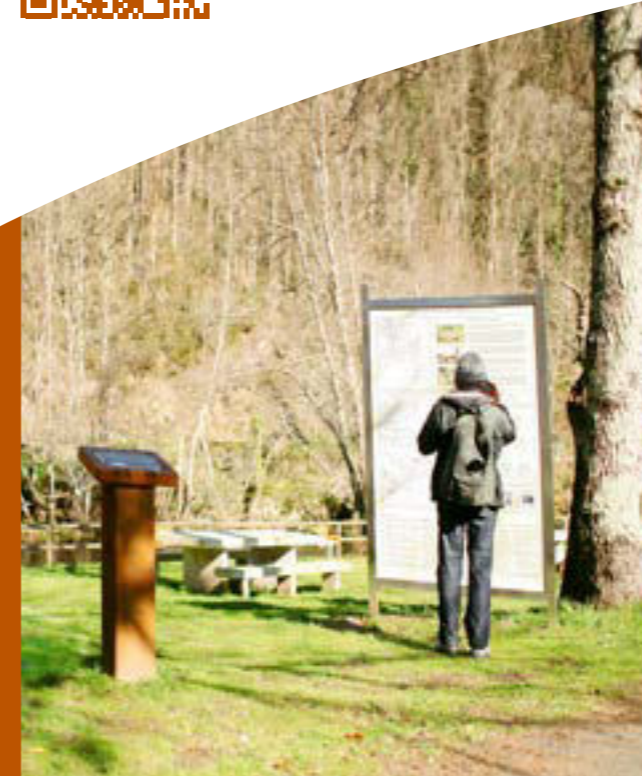
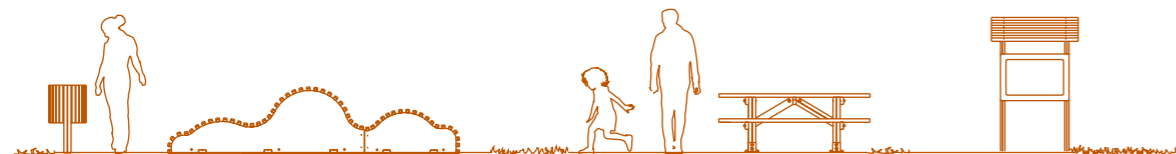

EN

As is the case with all public spaces, parks and leisure areas cannot be considered complete without the presence of Furniture. In Galopín we are guided by the desire to bring to the public space - that house we all share - the feeling of comfort that we enjoy in our homes.

Signs, bins, information panels, fences ... we look for simple designs that can be integrated into the environment and with the rest of the products from our ranges. Elements to guide and inform in a clear manner so that park users always have the data or services they need.

We take a special interest in the tables, benches and seating elements because parks are not only the natural setting of children, but also of adults and grandparents. That's why we study the curves of the backs or the angles of the seats with the same attention with which we design all our games. A well designed seat means rest, snack time, a place to leave the clothes that is not needed during playtime and then recovered to avoid getting cold. It is a dialogue, a social gathering and a coexistence.



FR

Comme dans le reste des espaces publics, les parcs et les zones de loisirs ne peuvent être considérés complets sans la contribution du mobilier. Chez Galopín nous sommes guidés par le désir d'apporter à l'espace public, cette maison de tous, le sentiment de bien-être et de confort que nous apprécions chez nous.

Éléments de signalisation, poubelles, panneaux d'information, palissades... nous recherchons des designs simples, qui s'intègrent à l'environnement et au reste des produits de nos gammes. Pour guider et signaler clairement afin que les utilisateurs du parc aient toujours les informations ou les services dont ils ont besoin.

Nous prenons particulièrement soin des tables, des bancs et autres éléments d'assise parce que les parcs ne sont pas seulement le territoire naturel des enfants, mais aussi celui des adultes et des grands-parents. C'est pourquoi nous étudions les courbes des dossiers ou les angles des sièges avec la même attention que nous portons à la réalisation de tous nos jeux. Un siège bien conçu est synonyme de repos, de temps de collation, c'est l'endroit idéal où laisser ses vêtements pendant le jeu. C'est aussi une invitation au dialogue, la rencontre sociale et la coexistence.



**AS01**

- m<sup>2</sup>
 155 x 50 cm
 45 cm
 1 u.
 -



**AS02**

- m<sup>2</sup>
 180 x 50 cm
 45 cm
 3 u.
 -



**AS03**

47,5 m<sup>2</sup>
 483 x 453 cm
 49 cm
 16 u.
 -



**ASBUBU**

- m<sup>2</sup>
 200 x 29 cm
 43 cm
 3 u.
 -



**BABUBU**

- m<sup>2</sup>
 200 x 45 cm
 43 cm
 3 u.
 -



**SIBUBU**

- m<sup>2</sup>
 50 x 45 cm
 43 cm
 1 u.
 -







**MC001**

- m<sup>2</sup>
 190 x 172 cm
 45 cm
 4 u.
 -









MEBUBUSE

 - m<sup>2</sup>
 200 x 88 cm
  - cm.
  4 u.
  -



ONDCEN

 19,3 m<sup>2</sup>
 200 x 123 cm
  44 cm
  2 u.
  -







Consultar posibles combinaciones.

Check possible combinations.

Consulter les combinaisons possibles.







MEBUBU

 - m<sup>2</sup>
 200 x 171 cm
  44 cm
  4 u.
  -



ONDLAR

 25,7 m<sup>2</sup>
 253 x 200 cm
  85 cm
  4 u.
  -





Consultar posibles combinaciones.

Check possible combinations.

Consulter les combinaisons possibles.



ONDCOR

 19,5 m<sup>2</sup>
 196 x 126 cm
  59 cm
  2 u.
  -



Consultar posibles combinaciones.



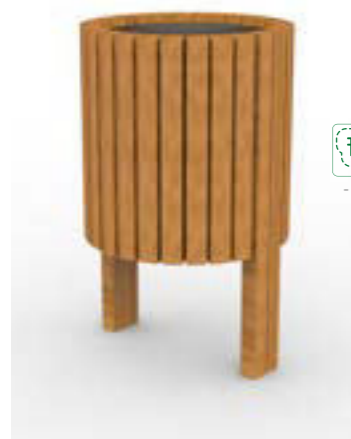

Check possible combinations.

Consulter les combinaisons possibles.









**CILIX**

 - m<sup>2</sup>
 49 x 49 cm
  - cm
  - cm
  -







**RELIX**

 - m<sup>2</sup>
 50 x 40 cm
  - cm
  - cm
  -







**F101A\_P**

 19,3 m<sup>2</sup>
 228 x 227 cm
  52 cm
  3 u.
  -







**F201A\_P**

 13,4 m<sup>2</sup>
 104 x 78 cm
  36 cm
  3 u.
  -



**F201B\_P**

 13,1 m<sup>2</sup>
 108 x 66 cm
  63 cm
  3 u.
  -





**F202A\_P**

14,2 m<sup>2</sup>
 122 x 118 cm
 52 cm
 4 u.
 -



**F313**

14,7 m<sup>2</sup>
 158 x 140 cm
 69 cm
 3 u.
 -



DIN33942



**PEZ11**

18,3 m<sup>2</sup>
 251 x 68 cm
 41 cm
 6 u.
 -

DIN33942

**CM10F01**

- m<sup>2</sup>
 180 x 40 cm
 45 cm
 5 u.
 -

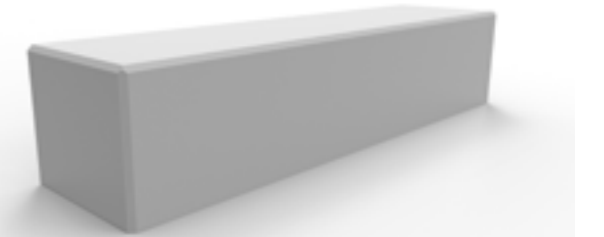

**CM10F02**

**CM10F03**

**CM10F04**

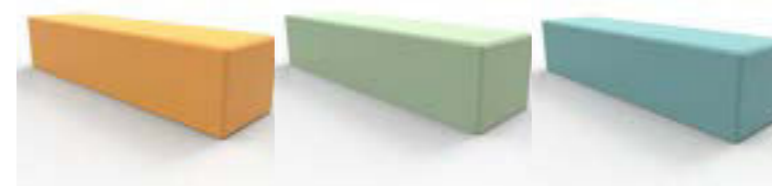

**CM11F01**

- m<sup>2</sup>
 70 x 60 cm
 45 cm
 1 u.
 -

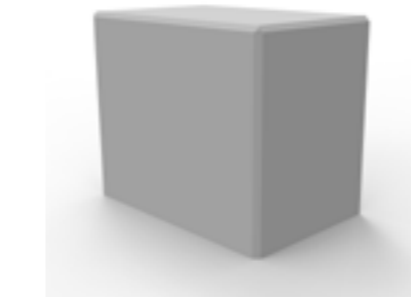

**CM11F02**

**CM11F03**

**CM11F04**



**CM12F01**

- m<sup>2</sup>
 180 x 65 cm
 45 cm
 5 u.
 -

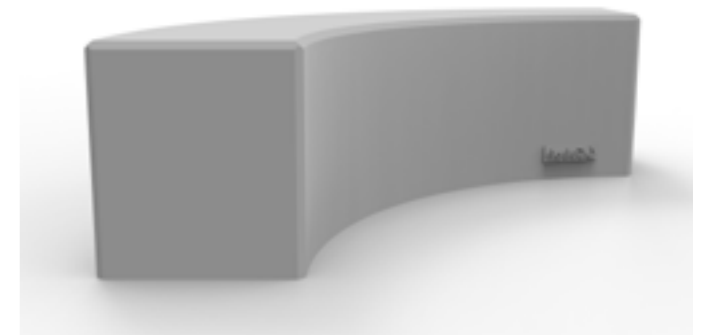

**CM12F02**

**CM12F03**

**CM12F04**





CASETE

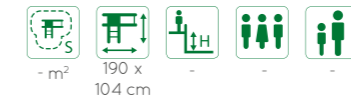

CASETEABI



CASETEABIDOBLE





**CASETEVI**

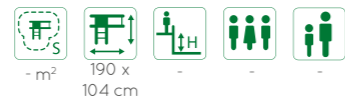

**CASETEPEABI**



**CASETESI-c1**

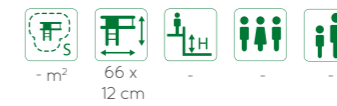

**CASETESI-c2**



**CASEPO**

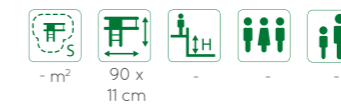

**CAMEIN**

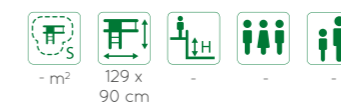





CDE01\_P



CASEALU



CASEBA



CASEATCHA

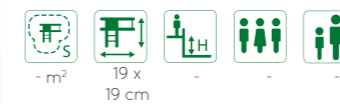

CP09



CAMOPO-c1



CAMOPO-c2



CASECUCHA

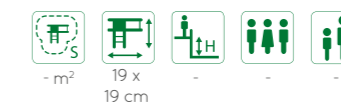





**CASEPI**

- m<sup>2</sup> 10 x 10 cm



Icons: - m<sup>2</sup>, 10 x 10 cm, wheelchair, two people, one person.

**CASEPICAM**

- m<sup>2</sup> 10 x 10 cm



Icons: - m<sup>2</sup>, 10 x 10 cm, wheelchair, two people, one person.

**CASEPICRU**

- m<sup>2</sup> 10 x 10 cm

Icons: - m<sup>2</sup>, 10 x 10 cm, wheelchair, two people, one person.

**CASEPIGI**

- m<sup>2</sup> 10 x 10 cm

Icons: - m<sup>2</sup>, 10 x 10 cm, wheelchair, two people, one person.



**CASEFLE**

- m<sup>2</sup> 56 x 10 cm

Icons: - m<sup>2</sup>, 56 x 10 cm, wheelchair, two people, one person.

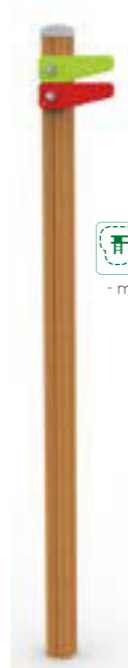
**CASELA**

- m<sup>2</sup> 29 x 10 cm

Icons: - m<sup>2</sup>, 29 x 10 cm, wheelchair, two people, one person.



**CASELACRU**

- m<sup>2</sup> 41 x 14 cm

Icons: - m<sup>2</sup>, 41 x 14 cm, wheelchair, two people, one person.



**CASELACAM**

- m<sup>2</sup> 29 x 14 cm

Icons: - m<sup>2</sup>, 29 x 14 cm, wheelchair, two people, one person.





**CASELAGI**

- m<sup>2</sup> 25 x 10 cm

Icons: - m<sup>2</sup>, 25 x 10 cm, wheelchair, two people, one person.

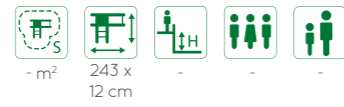

V03\_P



V06\_P



V03-N



V06-N\_P



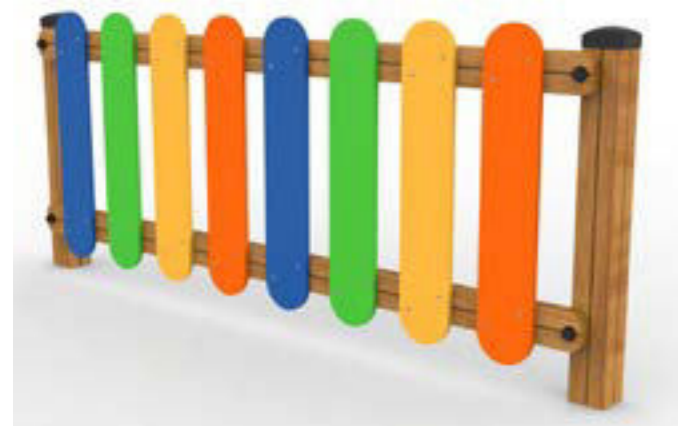

V01C\_P

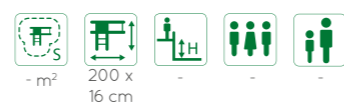

V02-N

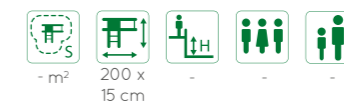

V01C\_P\_O



V02-O

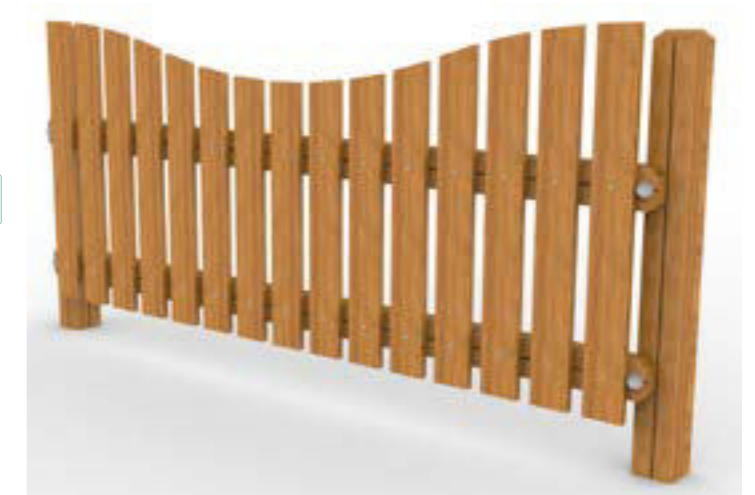
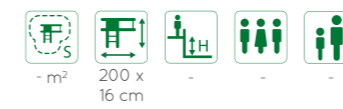

V02

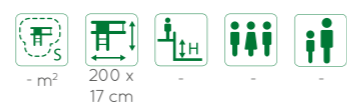

V02-T





V08

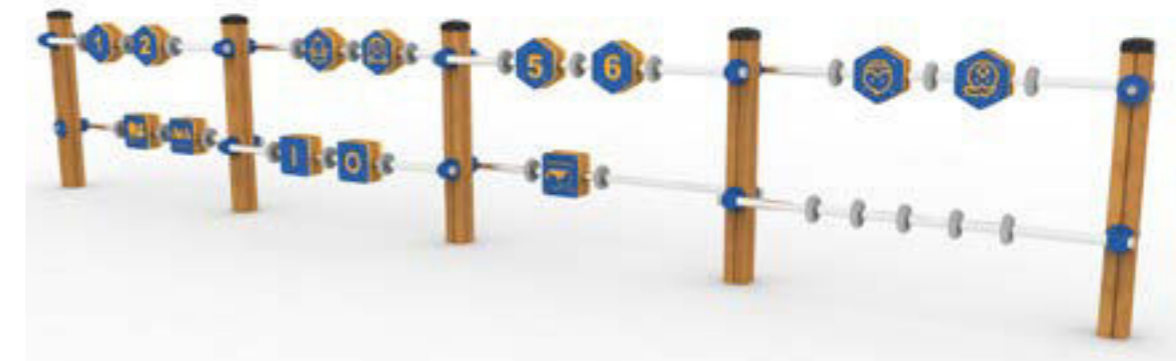

V09

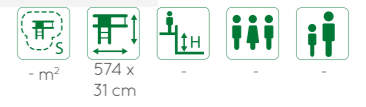

V08-G

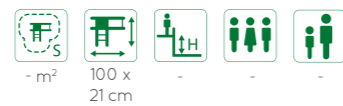

PV15

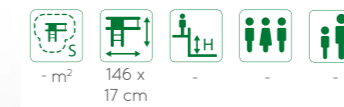

V15





V11



CP12





Deporte y Salud  
Sport and Health  
Sports et Santé



FR

Notre société valorise de plus en plus des habitudes saines et la qualité de vie. Notre gamme de Sports et de Santé a été créée pour encourager la pratique de l'exercice physique, indépendamment de l'âge ou du degré de préparation physique.

Pour répondre aux niveaux plus exigeants, nous avons créé la variante Callisthenique, qui cherche le développement de l'agilité, la force et la flexibilité avec un travail basé sur le mouvement du poids corporel sur les barres horizontales ou les bancs abdominaux, entre autres éléments.

Les « Saludables » rassemblent les besoins de base pour l'entretien du corps d'un adulte. On y trouve des éléments permettant aux personnes âgées de travailler leurs articulations, et proposant des exercices simples qui améliorent assidûment la vitalité. D'un autre côté, il y a aussi des éléments en bois, nos éléments Senior, conçus pour encourager l'exercice aérobique modéré, afin de promouvoir le bien-être de manière saine.

Nous proposons aussi des éléments pour réaliser des circuits à vélo, avec des rampes, des éléments en zig-zag, des obstacles ... le but est d'ajouter de nouveaux défis dans la pratique de l'exercice de ceux qui sortent faire des parcours en montagne ou en ville. Et bien sûr, nous ne laissons pas de côté les terrains multisports pour pratiquer des jeux d'équipe tels que le football ou le basketball. Parce que le sport, comme le jeu, n'est pas seulement l'exercice, mais l'interaction avec les autres. Nos éléments Sports et Santé sont conçus pour être associés aux différentes gammes de jeux pour enfants, pour concevoir des décors facilitant les loisirs en famille et la cohabitation intergénérationnelle.



EN

Our society values more and more healthy habits and wellbeing. Our range of Sports and Health equipment emerges from the desire to encourage physical exercise, regardless of age or physical condition.

For a more demanding workout, we have the Calisthenics variant, which seeks the development of agility, strength and flexibility based on the movement of the user's body weight on horizontal bars or abdominal benches, among other elements.

The Urban Health equipment is aimed at meeting the basic needs of adults when it comes to body maintenance. Here you can find units that focus on joints for the older generation, and propose simple and mild exercise, that when performed regularly improves vitality. Additionally, our wooden Senior elements are designed to encourage moderate aerobic exercise, promoting wellness in a healthy way.

We also have units for creating bicycle circuits, with ramps, zigzags, obstacles, etc., a complementary exercise for those who enjoy mountain biking and riding in general. And of course, we cannot forget multipurpose playing courts to practice team sports, such as football or basketball. Because sports, like play, not only provides physical exercise, but also encourages interaction with others. That is why our Sports and Health units are designed to be combined with the different ranges of children's games, to design sets that facilitate family leisure and intergenerational relationships.

## DEPORTE Y SALUD

Nuestra sociedad valora cada vez más los hábitos saludables y la calidad de vida. Nuestra gama de Deporte y Salud surge para animar a la práctica del ejercicio físico, con independencia de la edad o del diferente grado de preparación.

En un nivel de mayor exigencia tenemos la variante Calistenia, que busca el desarrollo de la agilidad, la fuerza y la flexibilidad con un trabajo basado en el movimiento del propio peso corporal en barras horizontales o bancos de abdominales, entre otros elementos.

Los Saludables urbanos recogen las necesidades básicas para el mantenimiento del cuerpo de un adulto. Cuentan con elementos centrados en las articulaciones para los más mayores, y propone ejercicios sencillos y

suaves que realizados con asiduidad mejoran el tono vital. Por otra parte también existen elementos en madera, nuestros elementos Senior, pensados para promover el ejercicio aeróbico moderado, de manera que se fomente el bienestar de modo saludable.

También contamos con elementos adecuados para diseñar circuitos de bicicleta, con rampas, elementos de zig-zag, obstáculos... una apuesta que complementa el ejercicio de quienes salen a realizar trayectos de paseo o montaña. Y por supuesto, no dejamos de lado las pistas multideporte para practicar juegos de equipo como fútbol o baloncesto. Porque el deporte, como el juego, es no solo ejercicio, sino interacción con los demás. Por eso, nuestros elementos de Deporte y Salud están pensados para combinarse con las distintas gamas de juegos infantiles, para diseñar conjuntos que faciliten el ocio familiar y la convivencia intergeneracional.

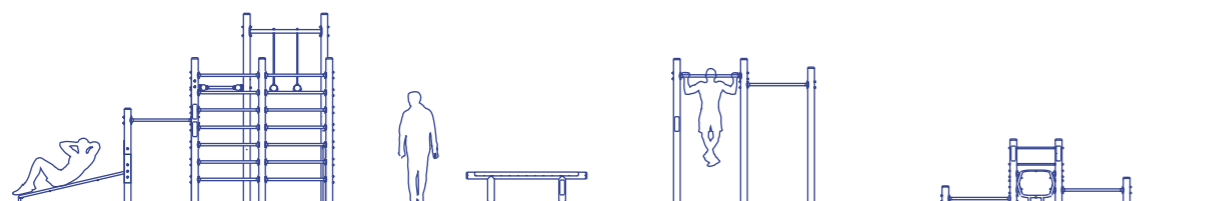





CDE02M

18,1 m<sup>2</sup> 193 x 92 cm 1 u. +14



CDE03M

24,3 m<sup>2</sup> 245 x 11 cm 2 u. +14

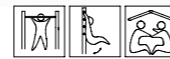

CDE04M

19,8 m<sup>2</sup> 360 x 11 cm 3 u. +14



CDE05M

18,6 m<sup>2</sup> 200 x 88 cm 1 u. +14

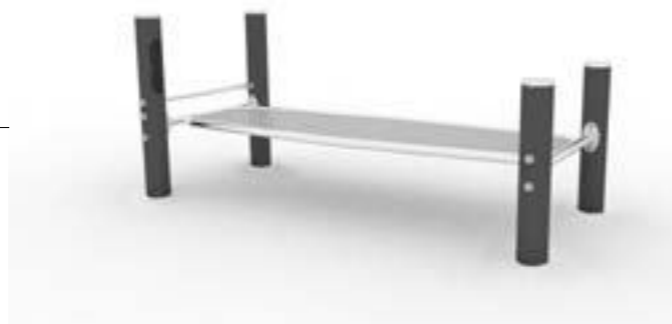

CDE06M

15,1 m<sup>2</sup> 126 x 82 cm 144 cm 1 u. +14



CDE07M

24,3 m<sup>2</sup> 245 x 11 cm 220 cm 2 u. +14

CDE07TM

29,2 m<sup>2</sup> 360 x 11 cm 220 cm 3 u. +14





CDE13M

14,3 m<sup>2</sup>
 203 x 12 cm
 53 cm
 2 u.
 +14

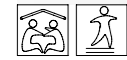

CDE23M

16 m<sup>2</sup>
 245 x 11 cm
 94 cm
 2 u.
 +14



CDE50M

20,2 m<sup>2</sup>
 254 x 100 cm
 99 cm
 2 u.
 +14



CDE52M

15,4 m<sup>2</sup>
 126 x 82 cm
 125 cm
 1 u.
 +14



CDE53M

21,5 m<sup>2</sup>
 148 x 113 cm
 191 cm
 1 u.
 +14





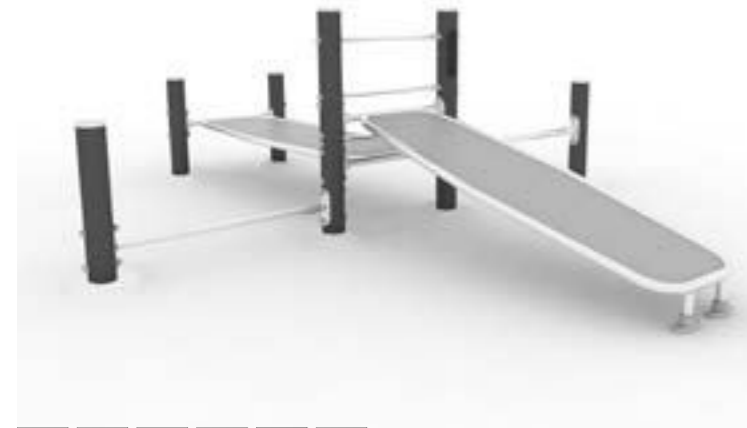

CDE100AM

50,7 m<sup>2</sup>
 547 x 444 cm
 220 cm
 7 u.
 +14









CDE200AM

 41,2 m<sup>2</sup>
 381 x 317 cm
  94 cm
  4 u.
  +14





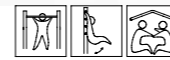

CDE300AM

 33,3 m<sup>2</sup>
 470 x 11 cm
  220 cm
  4 u.
  +14







CDE301AM

 23,8 m<sup>2</sup>
 126 x 126 cm
  220 cm
  4 u.
  +14







CDE500AM

 43 m<sup>2</sup>
 553 x 397 cm
  220 cm
  6 u.
  +14



CDE600AM

 20,7 m<sup>2</sup>
 308 x 88 cm
  144 cm
  2 u.
  +14





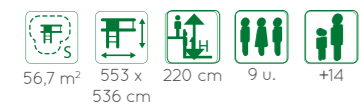

CDE800AM









CDE700AM

				
40,8 m <sup>2</sup>	370 x 529 cm	191 cm	5 u.	+14



GC09M

				
51,2 m <sup>2</sup>	661 x 381 cm	220 cm	8 u.	+14







CDE02

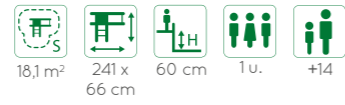

CDE03

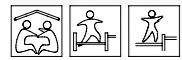
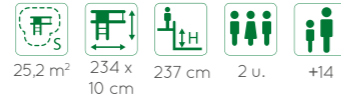

CDE04

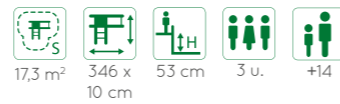

CDE05

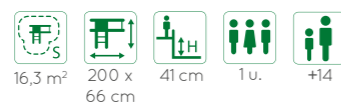

CDE06

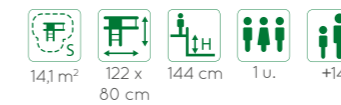

CDE07

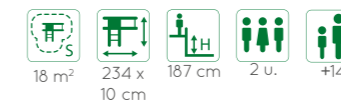

CDE07T

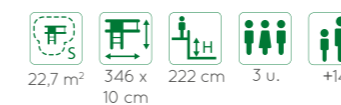



CDE09

11 m<sup>2</sup>
 120 x 40 cm
 10 cm
 1 u.
 +14



CDE11

8 m<sup>2</sup>
 19 x 10 cm
 - cm
 1 u.
 +14



CDE13

19,4 m<sup>2</sup>
 390 x 60 cm
 10 cm
 2 u.
 +14



CDE23

14,6 m<sup>2</sup>
 234 x 90 cm
 10 cm
 2 u.
 +14



CDE50

18,8 m<sup>2</sup>
 250 x 75 cm
 117 cm
 2 u.
 +14



CDE52

14,1 m<sup>2</sup>
 122 x 80 cm
 115 cm
 1 u.
 +14



CDE100A

51,7 m<sup>2</sup>
 525 x 411 cm
 237 cm
 7 u.
 +14

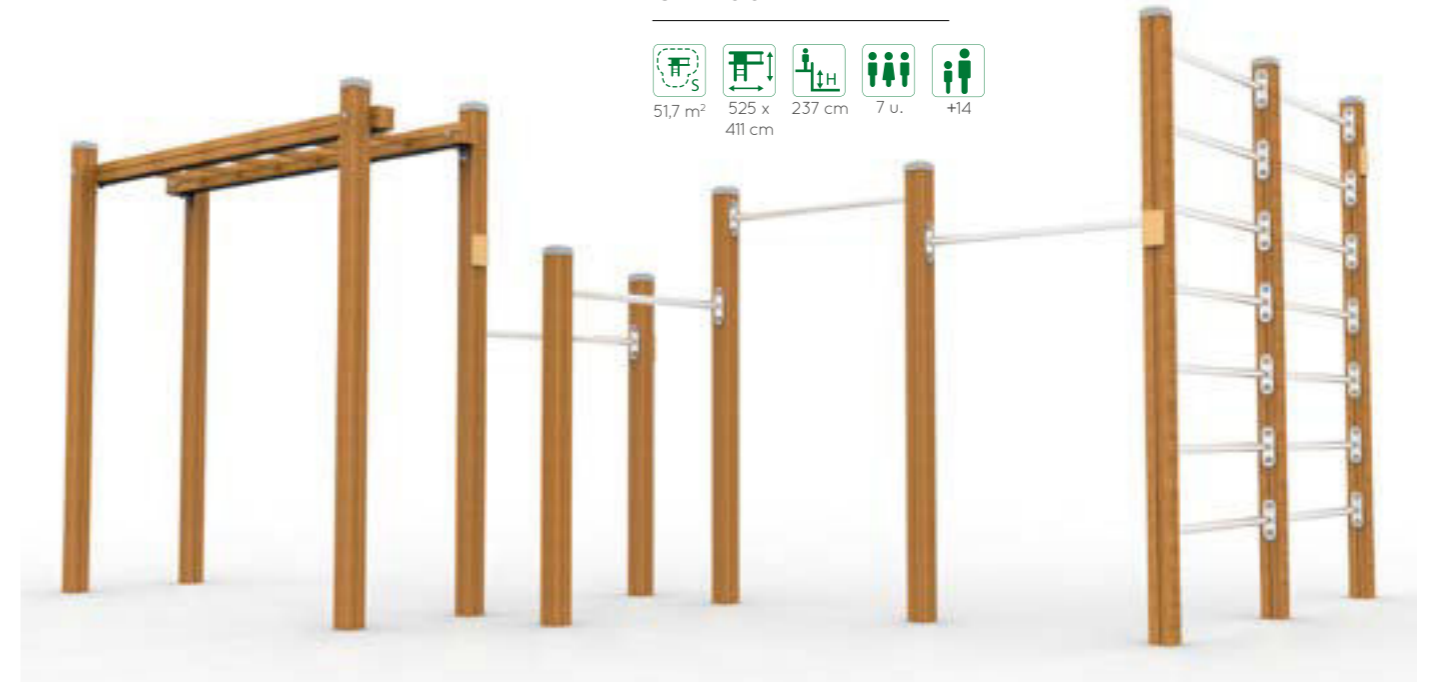





CDE200A

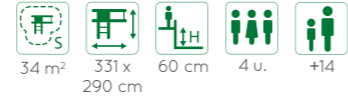

CDE300A

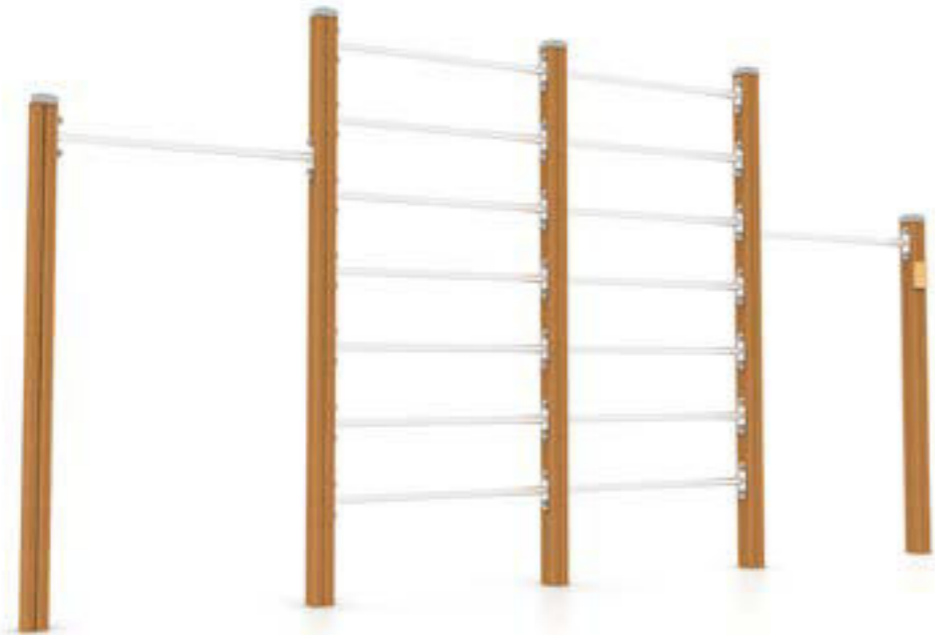
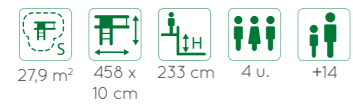





FR100A

24,7 m<sup>2</sup>
 364 x 175 cm
 96 cm
 2 u.
 +14

FR101A

16,7 m<sup>2</sup>
 175 x 171 cm
 96 cm
 1 u.
 +14

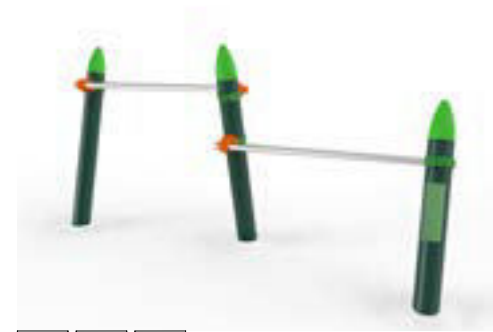

FR102A

18,8 m<sup>2</sup>
 242 x 90 cm
 65 cm
 2 u.
 +14

FR103A

25,4 m<sup>2</sup>
 357 x 120 cm
 60 cm
 3 u.
 +14



FR104A

31 m<sup>2</sup>
 312 x 74 cm
 220 cm
 2 u.
 +14



FR105A

13,8 m<sup>2</sup>
 203 x 11 cm
 49 cm
 2 u.
 +14

FR106A

17,7 m<sup>2</sup>
 218 x 77 cm
 59 cm
 1 u.
 +14

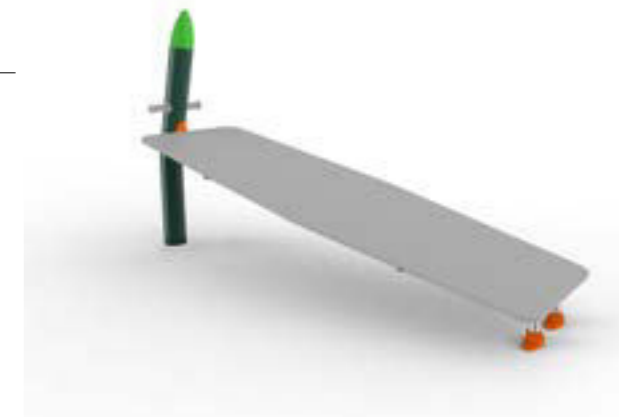





FR107A

18,1 m<sup>2</sup>
 230 x 77 cm
 28 cm
 1 u.
 +14







FR108A





 32,8 m<sup>2</sup>
 437 x 272 cm
  211 cm
  4 u.
  +14



FR109A



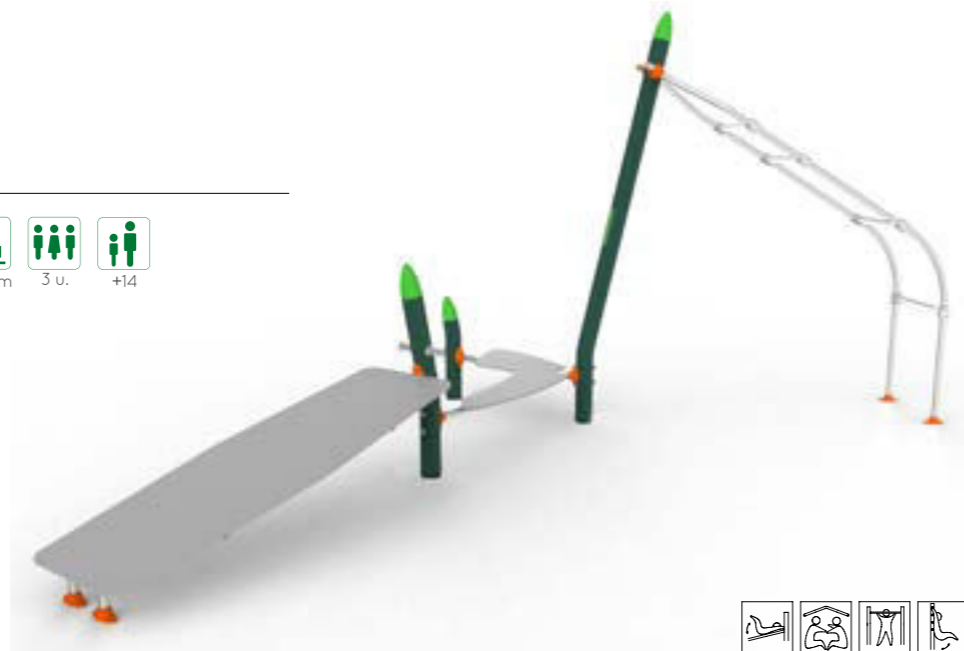

 18,9 m<sup>2</sup>
 135 x 69 cm
  211 cm
  1 u.
  +14

FR110A

 37,4 m<sup>2</sup>
 548 x 314 cm
  197 cm
  3 u.
  +14





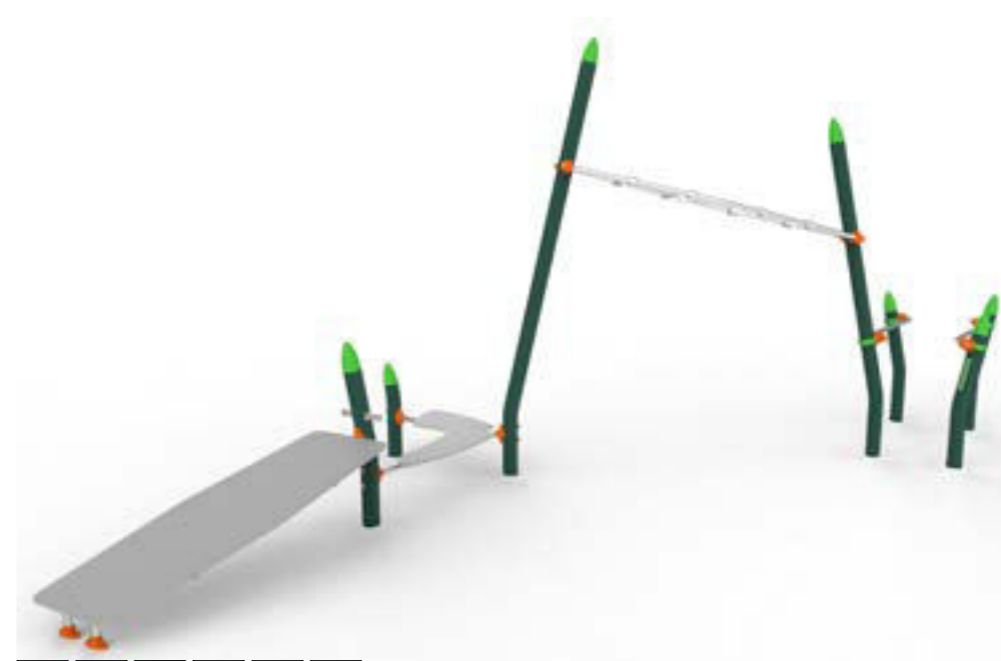

FR111A

 45,5 m<sup>2</sup>
 725 x 416 cm
  220 cm
  4 u.
  +14





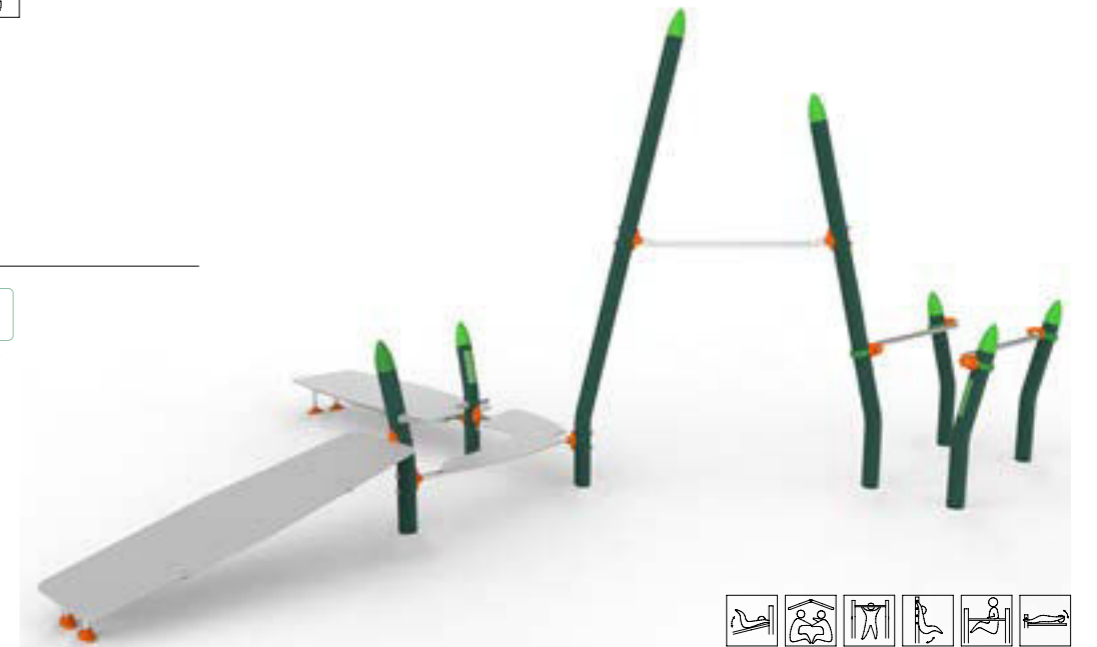

FR112A

 49,8 m<sup>2</sup>
 655 x 550 cm
  167 cm
  5 u.
  +14



FR113A

 26,5 m<sup>2</sup>
 427 x 77 cm
  59 cm
  2 u.
  +14



FRUIT

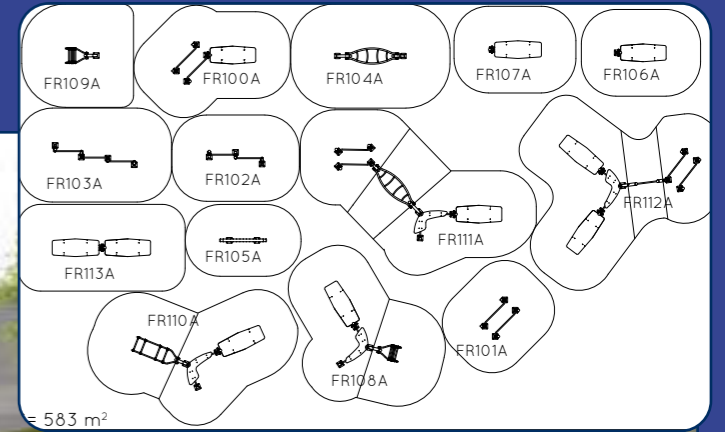

KINETIC POINT



K010N

37,3 m<sup>2</sup> 425 x 373 cm 209 cm 5 u. +14

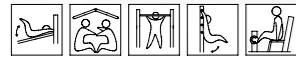

K020N

42 m<sup>2</sup> 514 x 194 cm 452 cm 6 u. +14



K030N

52 m<sup>2</sup> 784 x 224 cm 454 cm 10 u. +14



K040N

44,9 m<sup>2</sup> 590 x 224 cm 425 cm 10 u. +14

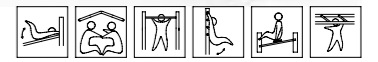

K050N

44,9 m<sup>2</sup> 720 x 167 cm 454 cm 9 u. +14



K060N

51,8 m<sup>2</sup> 851 x 209 cm 425 cm 8 u. +14



KINETIC POINT



K070N

54 m<sup>2</sup> 696 x 488 cm 167 cm 8 u. +14



K080N

61,1 m<sup>2</sup> 598 x 512 cm 209 cm 12 u. +14

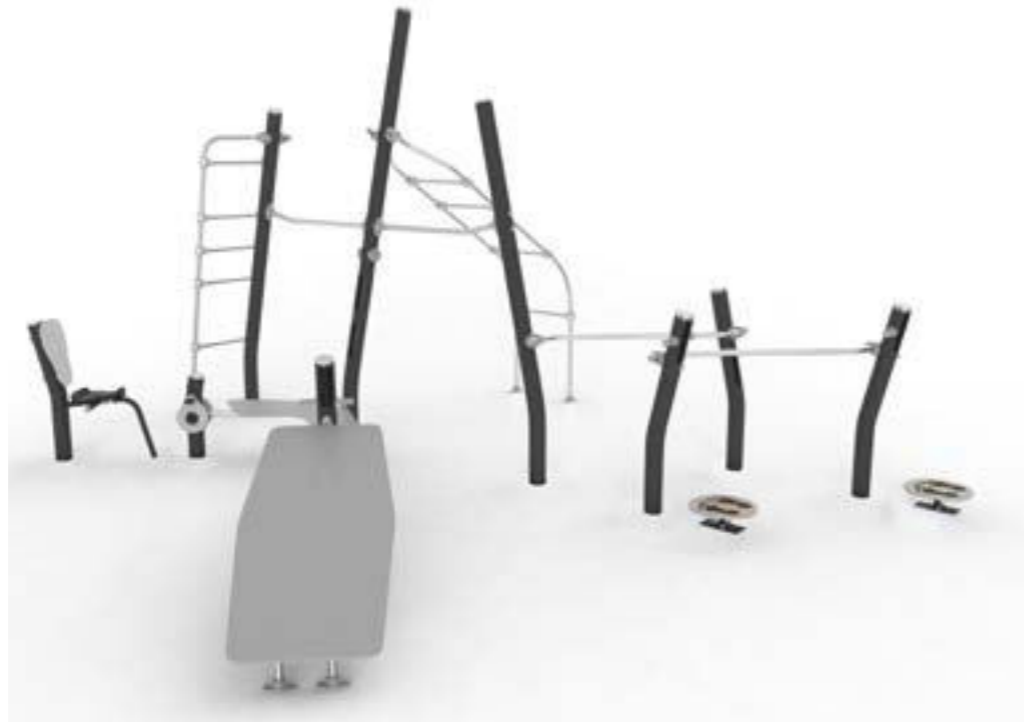

KINETIC POINT

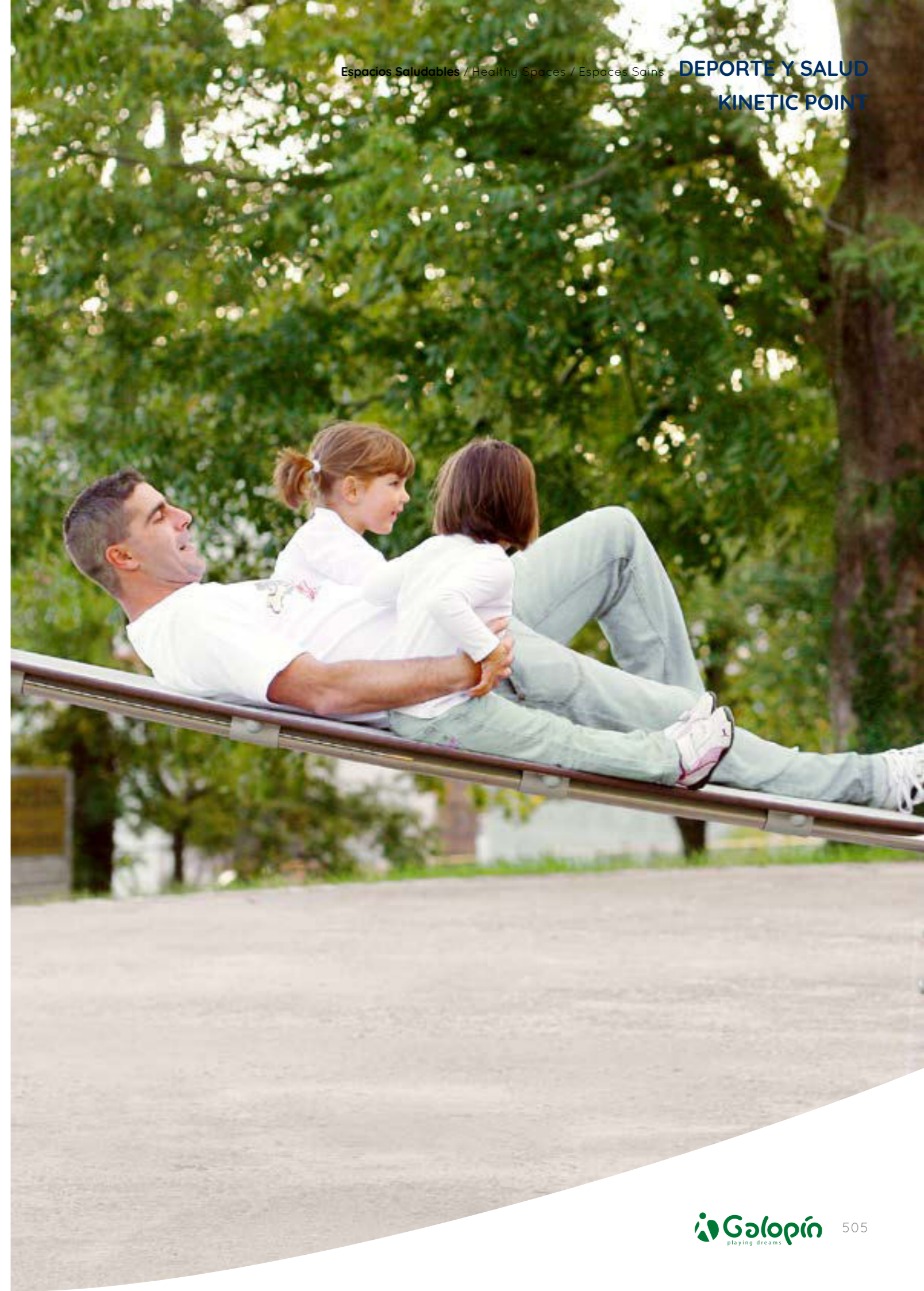

KINETIC POINT

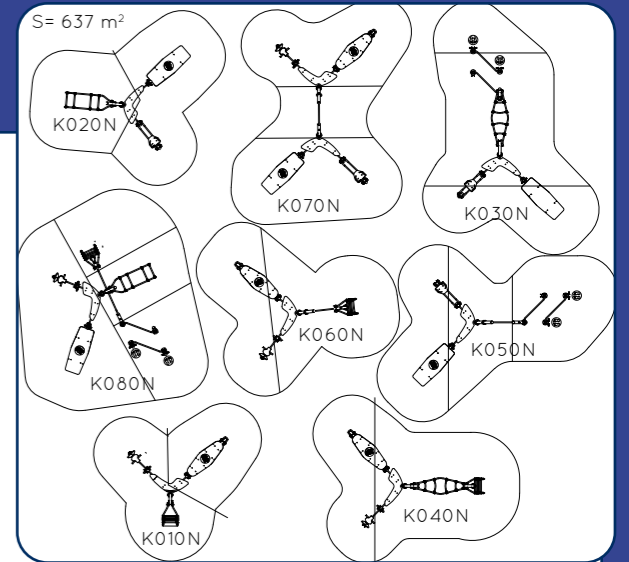





CDE08

16,2 m<sup>2</sup> 220 x 51 cm 52 cm 1 u. +14



CDE15

22,6 m<sup>2</sup> 270 x 131 cm 38 cm 1 u. +14



CDE10

20,2 m<sup>2</sup> 281 x 29 cm - cm 2 u. +14



CDE19

21,2 m<sup>2</sup> 449 x 11 cm 65 cm 1 u. +14



CDE12

30 m<sup>2</sup> 310 x 220 cm 79 cm 2 u. +14







CDE22

16,6 m<sup>2</sup> 300 x 20 cm 62 cm 2 u. +14









MU005

 15,8 m<sup>2</sup>
 245 x 27 cm
  78 cm
  2 u.
  +14







UG020

 19,4 m<sup>2</sup>
 192 x 180 cm
  210 cm
  4 u.
  +14







UG010

 21,9 m<sup>2</sup>
 298 x 155 cm
  106 cm
  4 u.
  +14



UG040

 48,5 m<sup>2</sup>
 463 x 377 cm
  217 cm
  8 u.
  +14





GC01

50,8 m<sup>2</sup> 410 x 321 cm 209 cm 4 u. +14



GC02

44 m<sup>2</sup> 419 x 312 cm 43 cm 4 u. +14



GC04

44 m<sup>2</sup> 419 x 312 cm 22 cm 4 u. +14



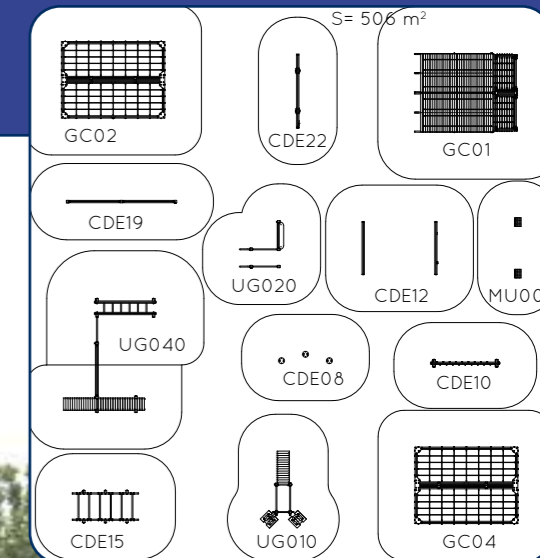



GA01

10,3 m<sup>2</sup>
 70 x 31 cm
 - cm
 1 u.
 +14



GA02

9,9 m<sup>2</sup>
 66 x 25 cm
 - cm
 1 u.
 +14



GA03

10,2 m<sup>2</sup>
 81 x 31 cm
 - cm
 1 u.
 +14



GA04

9,5 m<sup>2</sup>
 66 x 13 cm
 - cm
 1 u.
 +14



GA06

27,4 m<sup>2</sup>
 456 x 89 cm
 61 cm
 2 u.
 +14

GA07

11,2 m<sup>2</sup>
 66 x 60 cm
 12 cm
 1 u.
 +14



NATURA



GA08

22,9 m<sup>2</sup>
 355 x 79 cm
 18 cm
 2 u.
 +14

GA09

9,4 m<sup>2</sup>
 66 x 14 cm
 - cm
 1 u.
 +14



GA10

9,9 m<sup>2</sup>
 65 x 13 cm
 - cm
 1 u.
 +14



NATURA

GA11

13,2 m<sup>2</sup>
 113 x 65 cm
 44 cm
 1 u.
 +14



GA12

18 m<sup>2</sup>
 180 x 113 cm
 44 cm
 2 u.
 +14





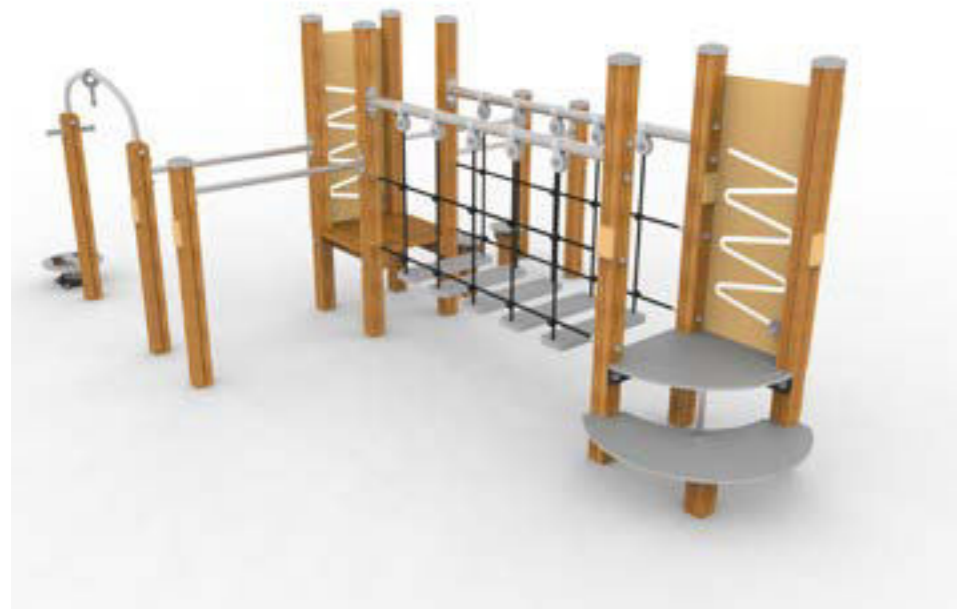

NATURA









UG030

 33,5 m<sup>2</sup>
 501 x 304 cm
  101 cm
  10 u.
  +14







UG070

 56,4 m<sup>2</sup>
 763 x 393 cm
  88 cm
  14 u.
  +14





UG050

 53,5 m<sup>2</sup>
 619 x 508 cm
  74 cm
  10 u.
  +14



UG080

 37,2 m<sup>2</sup>
 529 x 266 cm
  216 cm
  10 u.
  +14







UG060

69,7 m<sup>2</sup> 635 x 584 cm 96 cm. 16 u. +14



DEMODO FITNESS



JSA012R

14,6 m<sup>2</sup>
 165 x 56 cm
 37 cm
 1 u.
 +14



JSA013R

10 m<sup>2</sup>
 50 x 32 cm
 - cm
 1 u.
 +14



JSA014R

11,9 m<sup>2</sup>
 74 x 63 cm
 31 cm
 1 u.
 +14



FITNESS DEMODO



JSA017R

9,1 m<sup>2</sup>
 40 x 17 cm
 - cm
 1 u.
 +14



JSA024R

13,5 m<sup>2</sup>
 121 x 66 cm
 34 cm
 1 u.
 +14

JSA028R

13,3 m<sup>2</sup>
 133 x 52 cm
 49 cm
 1 u.
 +14





JSA027R

10,4m<sup>2</sup> 40 x 61 cm 16 cm 1 u. +14



JSA029R

13,7 m<sup>2</sup> 163 x 21 cm - cm 1 u. +14



JSA030R

20,4 m<sup>2</sup> 213 x 11 cm 153 cm 1 u. +14

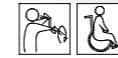

JSA031R

11,6 m<sup>2</sup> 110 x 11 cm - cm 1 u. +14

JSA032R

12,8 m<sup>2</sup> 121 x 50 cm 46 cm 2 u. +14



JSA044R

15,8 m<sup>2</sup> 164 x 75 cm 46 cm 2 u. +14



UG810R

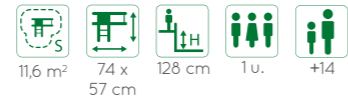

UG910R

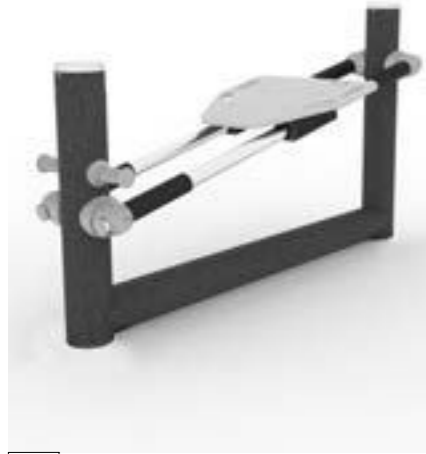
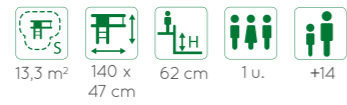

TW001R

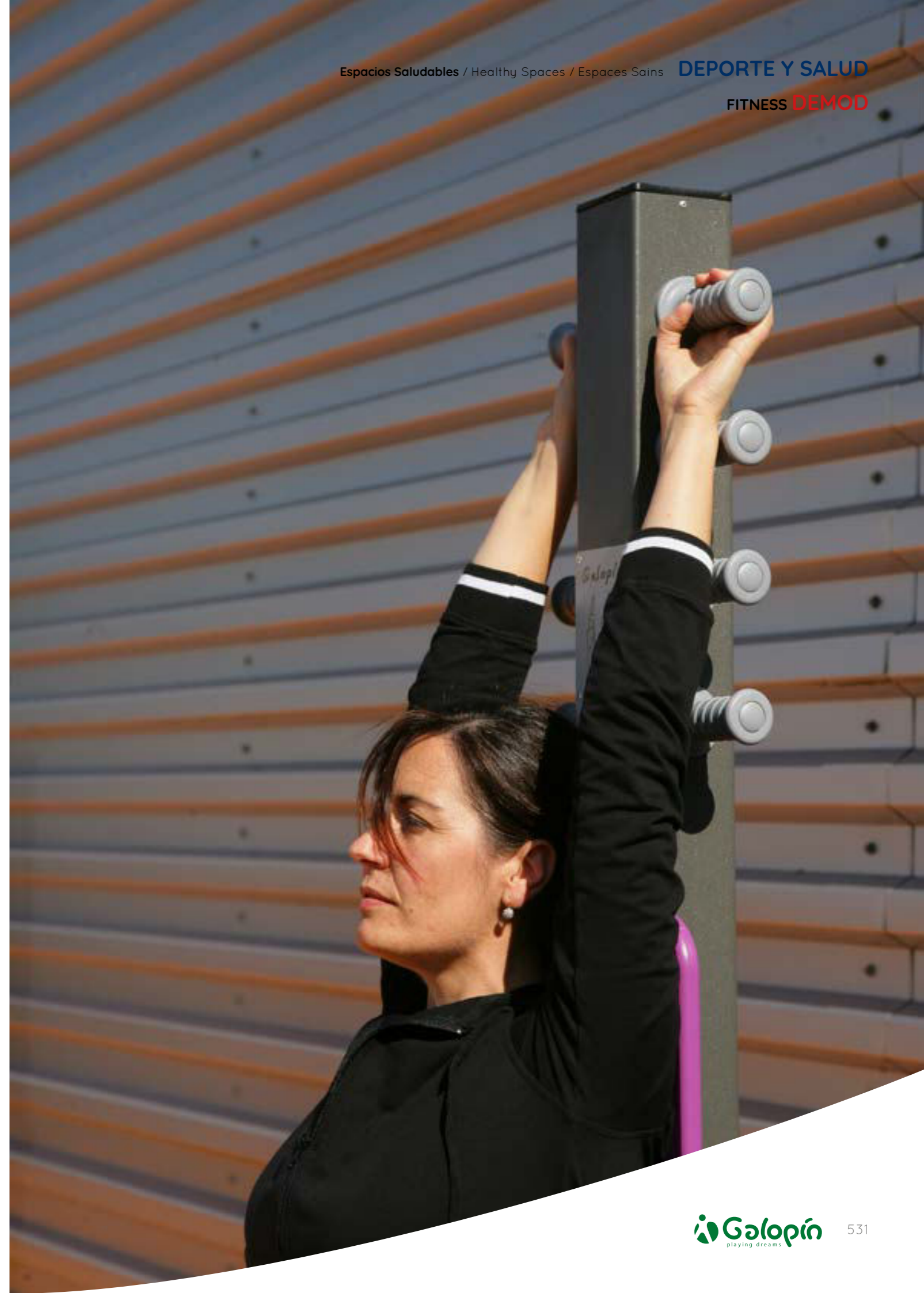
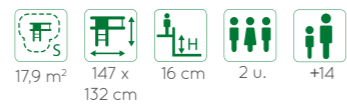

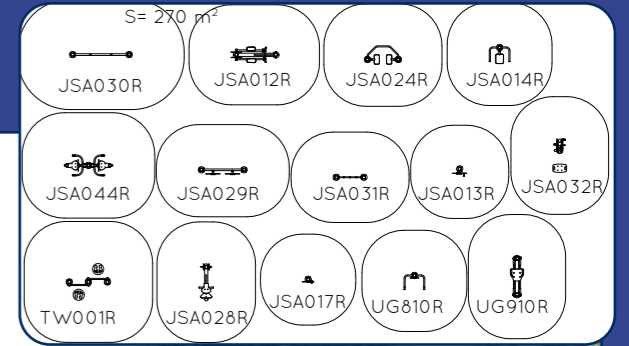



UG010M

25,4 m<sup>2</sup>
 353 x 181 cm
 89 cm
 4 u.
 +14



UG020M

21,1 m<sup>2</sup>
 196 x 184 cm
 203 cm
 4 u.
 +14



UG080M

37,2 m<sup>2</sup>
 550 x 306 cm
 167 cm
 10 u.
 +14



UG050M

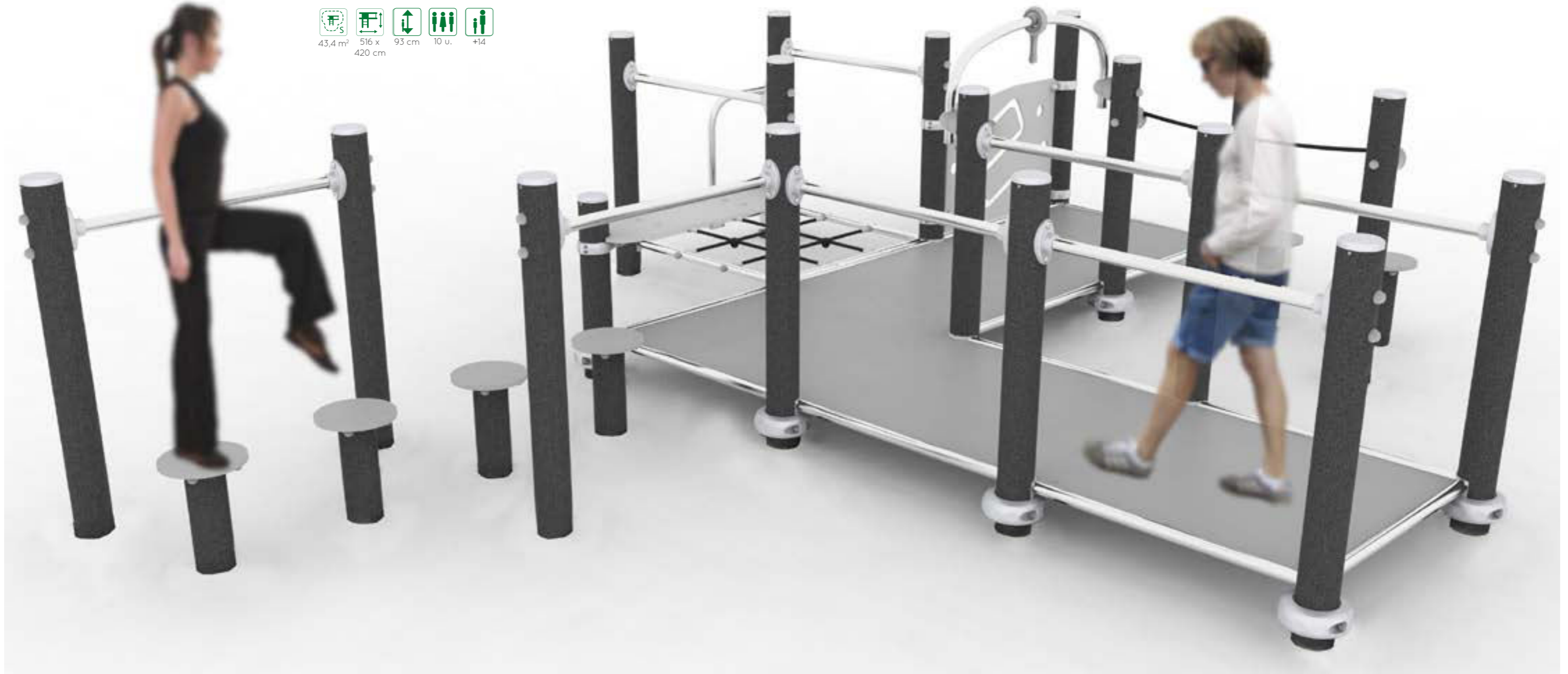
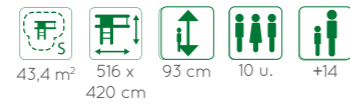

URBAN FITNESS



JSA012

14,6 m<sup>2</sup>
 164 x 56 cm
 34 cm
 1 u.
 +14

FITNESS URBAN



JSA015

9,3 m<sup>2</sup>
 53 x 19 cm
 - cm
 1 u.
 +14

JSA013

9,7 m<sup>2</sup>
 50 x 30 cm
 - cm
 1 u.
 +14



JSA016

11,1 m<sup>2</sup>
 79 x 42 cm
 - cm
 1 u.
 +14

JSA014

11,9 m<sup>2</sup>
 74 x 63 cm
 31 cm
 1 u.
 +14



JSA017

9,1 m<sup>2</sup>
 40 x 20 cm
 - cm
 1 u.
 +14





URBAN FITNESS



JSA018

- 7,7 m<sup>2</sup>
- 18 x 12 cm
- cm
- 1 u.
- +14



JSA019

- 8,5 m<sup>2</sup>
- 31 x 12 cm
- cm
- 1 u.
- +14



JSA024

- 13,4 m<sup>2</sup>
- 120 x 66 cm
- 34 cm
- 1 u.
- +14



FITNESS URBAN

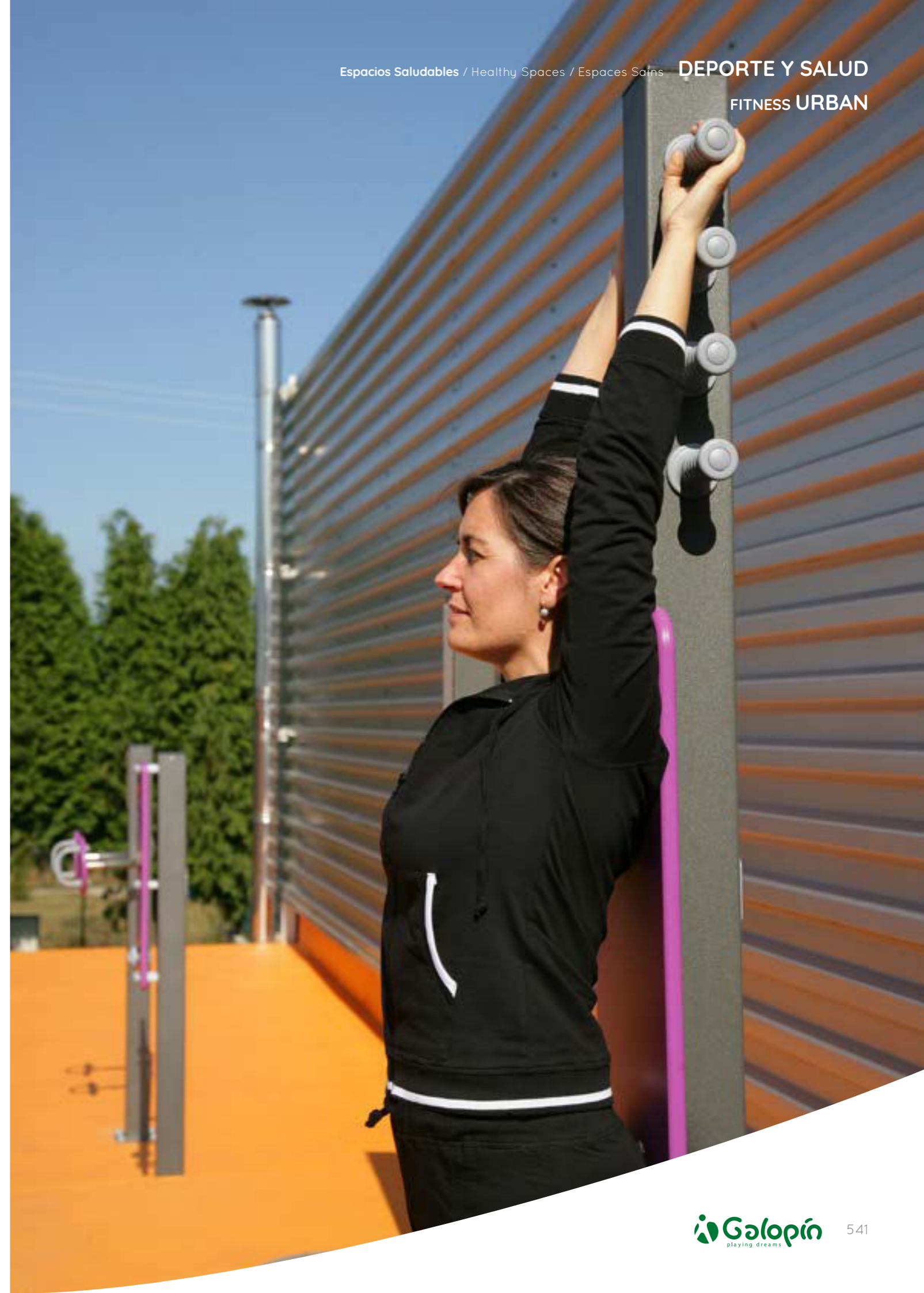



JSA027

10,3 m<sup>2</sup>
 60 x 40 cm
 16 cm
 1 u.
 +14



JSA028

13,2 m<sup>2</sup>
 132 x 52 cm
 49 cm
 1 u.
 +14



JSA029

13,4 m<sup>2</sup>
 160 x 21 cm
 - cm
 1 u.
 +14



JSA030

19,9m<sup>2</sup>
 210 x 10 cm
 154 cm
 1 u.
 +14



JSA031

11,8 m<sup>2</sup>
 107 x 10 cm
 - cm
 1 u.
 +14

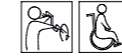

JSA032

12,8 m<sup>2</sup>
 119 x 50 cm
 45 cm
 2 u.
 +14



JSA045

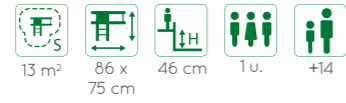

TW001

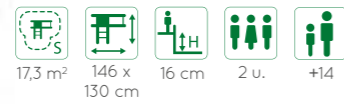

UG910

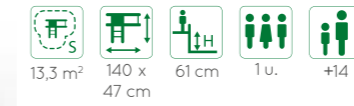

UG1010

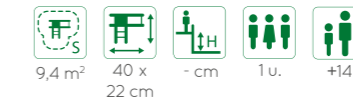

URBAN FITNESS



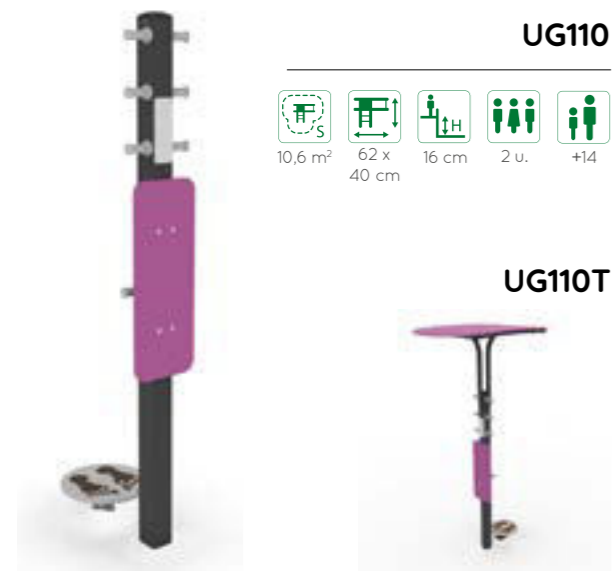

UG110

10,6 m<sup>2</sup> 62 x 40 cm 16 cm 2 u. +14



UG110T



UG111

29,7 m<sup>2</sup> 412 x 152 cm 53 cm 7 u. +14



UG210

15,4 m<sup>2</sup> 172 x 69 cm 34 cm 3 u. +14



UG210T



UG310

11,8 m<sup>2</sup> 79 x 62 cm 79 cm 2 u. +14



UG310T



UG311

35,9 m<sup>2</sup> 399 x 230 cm 47 cm 9 u. +14



UG510

18,9 m<sup>2</sup> 248 x 74 cm 49 cm 2 u. +14

UG510T



UG211

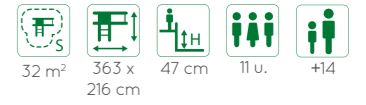

UG410T

- 26,4 m<sup>2</sup>
- 401 x 104 cm
- 49 cm
- 3 u.
- +14



UG410



UG610

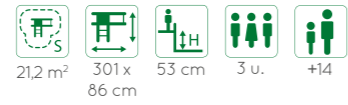

21,2 m<sup>2</sup> 301 x 53 cm 3 u. +14



UG610T



UG710

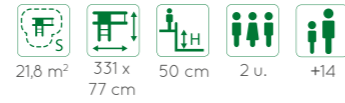

21,8 m<sup>2</sup> 331 x 50 cm 2 u. +14



UG710T

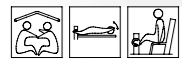

UG810

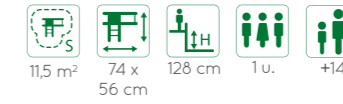

11,5 m<sup>2</sup> 74 x 128 cm 1 u. +14



UG810T



UG810D

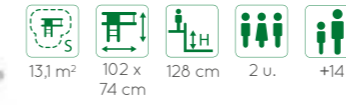

13,1 m<sup>2</sup> 102 x 74 cm 2 u. +14







CDE16

19,5 m<sup>2</sup>
 343x 350 cm
 39 cm
 1 u.
 +12



CDE25

17 m<sup>2</sup>
 240 x 50 cm
 22 cm
 1 u.
 +12



CDE18

25,5 m<sup>2</sup>
 340x 129 cm
 36 cm
 1 u.
 +12

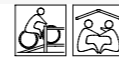

CDE26

27,4 m<sup>2</sup>
 648 x 10 cm
 - cm
 1 u.
 +12



CDE24

16 m<sup>2</sup>
 129 x 120 cm
 48 cm
 1 u.
 +12



CDE27

17,2 m<sup>2</sup>
 250 x 48 cm
 - cm
 1 u.
 +12



BICICLETAS



CDE28

18,4 m<sup>2</sup>
 250 x 69 cm
 11 cm
 1 u.
 +12



CDE35

60,6 m<sup>2</sup>
 1012 x 176 cm
 21 cm
 1 u.
 +12



CDE36

59,5 m<sup>2</sup>
 630 x 620 cm
 - cm
 1 u.
 +12



BICICLETAS

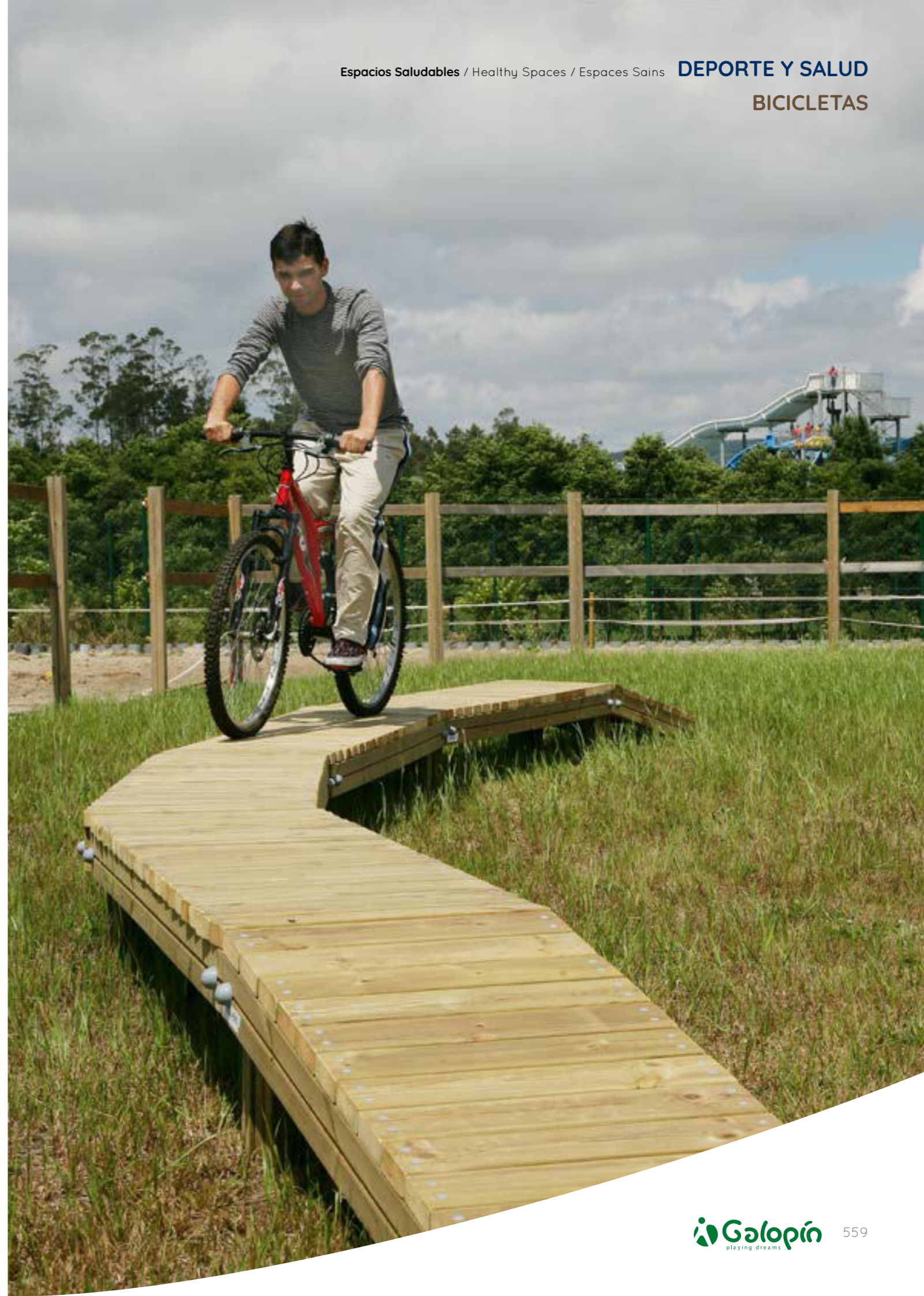

BICICLETAS



CDE37

23 m<sup>2</sup>
 269 x 139 cm
 - cm
 1 u.
 +12



BICICLETAS



CDE40

16 m<sup>2</sup>
 279 x 10 cm
 - cm
 1 u.
 +12



CDE38

28,7 m<sup>2</sup>
 393 x 142 cm
 - cm
 1 u.
 +12



CDE42

40,6 m<sup>2</sup>
 352 x 352 cm
 57 cm
 1 u.
 +12



CDE39

33,5 m<sup>2</sup>
 498 x 144 cm
 - cm
 1 u.
 +12



BICICLETAS

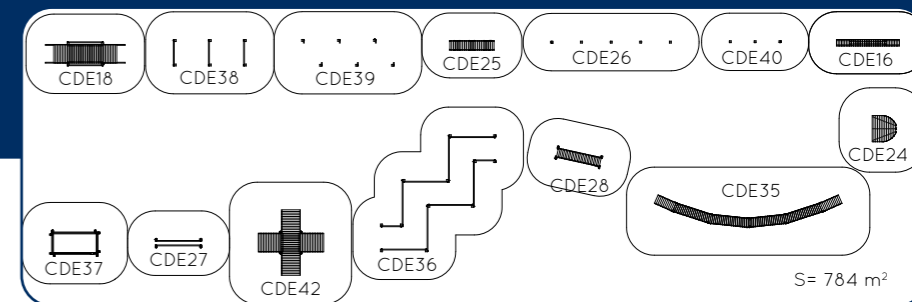



CDE30-O

23 m<sup>2</sup>
 116 x 219 cm
 - cm
 5 u.
 +14



CDE30-R

23 m<sup>2</sup>
 180 x 219 cm
 - cm
 5 u.
 +14

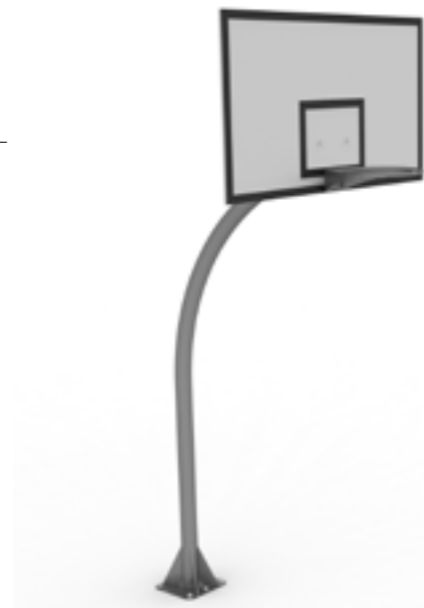

CDE33

22,9 m<sup>2</sup>
 125 x 244 cm
 - cm.
 1 u.
 +14



ROCO

- m<sup>2</sup>
 727 x 625 cm
 95 cm
 8 u.
 +12





PISTALTD



- m<sup>2</sup> - cm - cm 22 u. +6



RED DE VOLEIBOL / WITH VOLLEYBALL NET / ROUGE DE VOLEIBOL



PORTERÍAS BRASILEÑAS / BRAZILIAN SOCCER GOALS / BUTS DE FOOTBALL BRÉSILIENS



**M**  
LISTONES DE PINO TRATADO 200x33mm  
TREATED PINE STRIPS 200x33mm  
LAMES DE PIN TRAITÉ 200x33mm



**P**  
TABLERO DE POLIETILENO DE ESPESOR 15 mm  
POLYETHYLENE PANEL 15 mm THICK.  
PANNEAU EN POLYÉTHYLÈNE 15 mm D'ÉPAISSEUR.



**H**  
TABLERO DE HPL DE ESPESOR 10 mm  
HPL PANEL 10mm THICK.  
PANNEAU EN HPL 10mm D'ÉPAISSEUR.



L		A											
		AP (m)	AT (m)	AP (m)	AT (m)	AP (m)	AT (m)	AP (m)	AT (m)	AP (m)	AT (m)		
LP (m)	LT (m)	9,67	9,67	14	14	18,33	18,33	22,66	22,66	26,99	26,99	LxA (m <sup>2</sup> )	
17,41	19,67	168,31	190,16										
19,57	21,83			273,98	305,62								
21,74	24,00			304,29	335,93								
23,90	26,16			334,60	366,24								
26,07	28,33			364,91	396,55								
28,23	30,49					517,46	558,88						
30,40	32,66					557,14	598,57						
32,56	34,82					596,82	638,25	737,81	789,02				
34,73	36,99					636,51	677,94	786,87	838,08				
36,89	39,15							835,93	887,14	995,66	1056,66		
39,06	41,32							884,99	936,20	1054,09	1115,09		
41,22	43,48									1112,53	1173,53		
43,39	45,65									1170,96	1231,96		

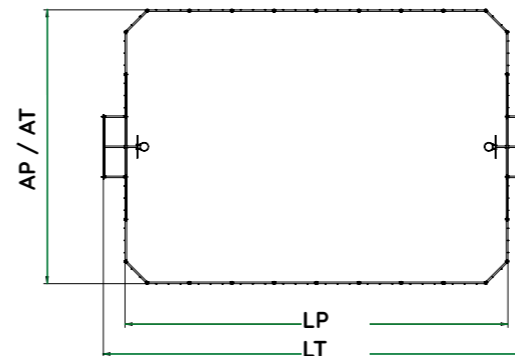

**O**  
TABLERO DE CANASTA OVALADO  
OVAL BASKET BOARD  
TABLEAU DE PANIER DE BASKET OVALE



**R**  
TABLERO DE CANASTA RECTANGULAR REGLAMENTARIO  
RECTANGULAR REGULATORY BASKET BOARD  
TABLEAU DE PANIER RÉGULATEUR RECTANGULAIRE





PISTASTD



RED DE VOLEIBOL / WITH VOLLEYBALL NET / ROUGE DE VOLEIBOL



**O**  
TABLERO DE CANASTA OVALADO  
OVAL BASKET BOARD  
TABLEAU DE PANIER DE BASKET OVALE

**R**  
TABLERO DE CANASTA RECTANGULAR REGLAMENTARIO  
RECTANGULAR REGULATORY BASKET BOARD  
TABLEAU DE PANIER RÉGULATEUR RECTANGULAIRE



**T**  
MALLA DOBLE ELECTROSOLDADA  
DOUBLE ELECTROSOLDED MESH  
MAILLE DOUBLE ÉLECTROSOLDÉE

**M**  
LISTONES DE PINO TRATADO 95x33mm  
TREATED PINE STRIPS 95x33mm  
LAMES DE PIN TRAITÉ 95x33mm

**P**  
TABLERO DE POLIETILENO DE ESPESOR 20mm  
POLYETHYLENE PANEL 20mm THICK  
PANNEAU EN POLYÉTHYLÈNE 20mm D'ÉPAISSEUR

**H**  
TABLERO DE HPL DE ESPESOR 15mm  
HPL PANEL 15mm THICK  
PANNEAU EN HPL 15mm D'ÉPAISSEUR



L		A											
		AP (m)	AT (m)	AP (m)	AT (m)	AP (m)	AT (m)	AP (m)	AT (m)	AP (m)	AT (m)	AP (m)	AT (m)
		7,34	9,54	11,58	13,78	15,82	18,02	20,06	22,26	24,30	26,5	24,30	26,5
LP (m)	LT (m)	LxA (m²)											
13,82	16,02	101,44	152,83	160,04	220,76	218,63	288,68						
18,06	20,26	132,56	193,28	209,13	279,18	285,71	365,09						
22,30	24,50			258,23	337,61	352,79	441,49						
26,54	28,74					419,86	517,89	532,39	639,75				
30,78	32,98							617,45	734,13	747,95	873,97		
35,02	37,22							702,50	828,52	850,99	986,33	999,47	1144,14
39,26	41,46							787,56	922,90	954,02	1098,69	1120,48	1274,48

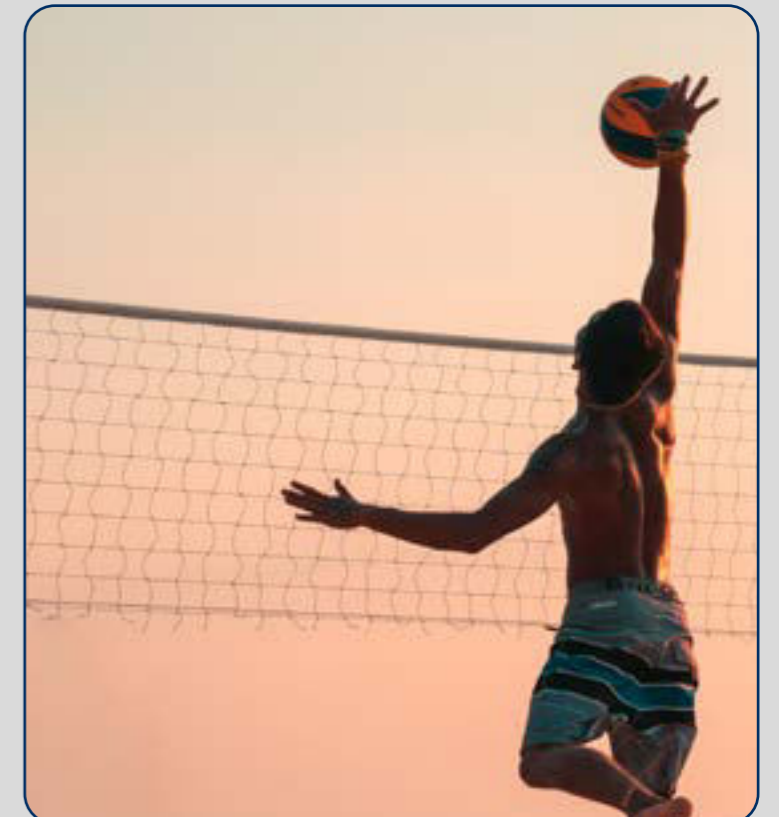
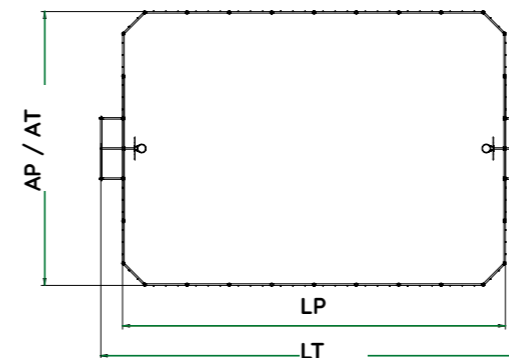



FONDLTD

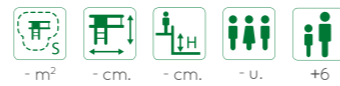

**M**  
LISTONES DE PINO TRATADO 200x33mm  
TREATED PINE STRIPS 200x33mm  
LAMES DE PIN TRAITÉ 200x33mm



**P**  
TABLERO DE POLIETILENO DE ESPESOR 15 mm  
POLYETHYLENE PANEL 15 mm THICK.  
PANNEAU EN POLYÉTHYLÈNE 15 mm D'ÉPAISSEUR.



**H**  
TABLERO DE HPL DE ESPESOR 10 mm  
HPL PANEL 10mm THICK.  
PANNEAU EN HPL 10mm D'ÉPAISSEUR.



**O**  
TABLERO DE CANASTA OVALADO  
OVAL BASKET BOARD  
TABLEAU DE PANIER DE BASKET OVALE



**R**  
TABLERO DE CANASTA RECTANGULAR REGLAMENTARIO  
RECTANGULAR REGULATORY BASKET BOARD  
TABLEAU DE PANIER RÉGULATEUR RECTANGULAIRE

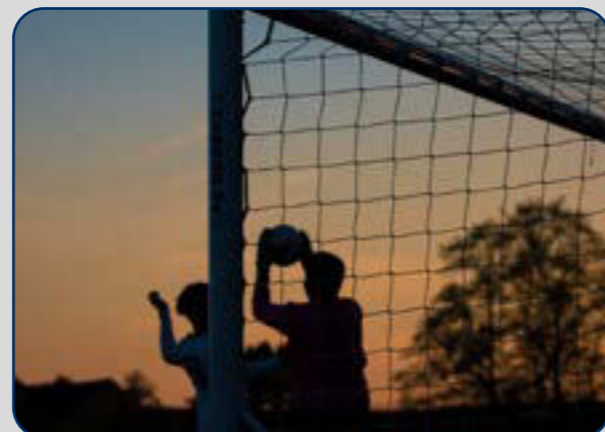

FONDSTD



**M**  
LISTONES DE PINO TRATADO 95x33mm  
LAMES DE PIN TRAITÉ 95x33mm  
TREATED PINE STRIPS 95x33mm



**P**  
TABLERO DE POLIETILENO DE ESPESOR 20mm  
PANNEAU EN POLYÉTHYLÈNE 20mm D'ÉPAISSEUR.  
POLYETHYLENE PANEL 20mm THICK.



**H**  
TABLERO DE HPL DE ESPESOR 15mm  
PANNEAU EN HPL 15mm D'ÉPAISSEUR.  
HPL PANEL 15mm THICK.



**O**  
TABLERO DE CANASTA OVALADO  
OVAL BASKET BOARD  
TABLEAU DE PANIER DE BASKET OVALE



**R**  
TABLERO DE CANASTA RECTANGULAR REGLAMENTARIO  
RECTANGULAR REGULATORY BASKET BOARD  
TABLEAU DE PANIER RÉGULATEUR RECTANGULAIRE

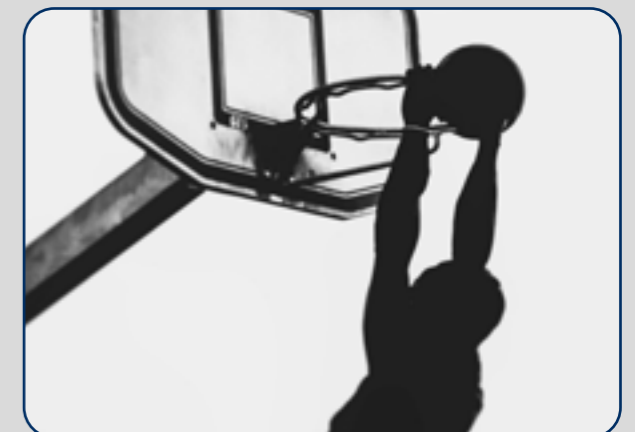





Canes  
Canes  
Canes



# CANES

Las ciudades son entidades dinámicas y quienes actuamos en ellas debemos estar siempre atentos a las nuevas demandas de sus habitantes. En las últimas décadas se ha incrementado la necesidad de zonas acotadas en las que los dueños de mascotas puedan disfrutar de un rato de ocio con sus animales.

Nuestra gama Canes responde a este nuevo estilo de vida desde una triple premisa de bienestar: garantizar módulos de ejercicio adecuados para los animales; garantizar un diseño de parque que responda a las demandas de sus dueños; garantizar una correcta delimitación de zonas. Porque aunque defendemos el contacto con la naturaleza como fuente de bienestar, dicho contacto debe de ser siempre voluntario.

Asesorados por veterinarios y entrenadores, hemos adaptado al entorno urbano algunos de los elementos de los circuitos de agility, al tiempo que proponemos una guía básica de confección de espacios para ocio compartido: recinto vallado; entrada con doble puerta, para evitar que los perros escapen cuando entra un nuevo visitante, fuente con agua, expendedores de bolsas para excrementos, bancos para los dueños... El ocio con animales supone una fuente de bienestar y el diseño de este tipo de espacios fomenta la tolerancia cívica: todos podemos compartir los espacios públicos desde la premisa del respeto y la seguridad.

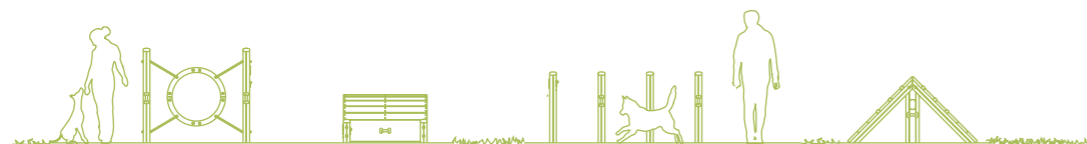

EN

Cities are dynamic entities, and those of us who are dedicated to working in this field must always be in tune with the new demands of their inhabitants. In recent decades, we have seen an ever-growing need for areas that are closed-off and where pet owners can enjoy leisure time with their cherished companions.

Our CANES range responds to this new lifestyle parting from a triple premise: to provide exercise modules that are suitable for pets, to offer parks designed to meet the demands of their owners, and to guarantee parks with well-defined boundaries of the area. Although we advocate contact with nature as a source of wellbeing, this contact must always be voluntary.

Following the advice of veterinarians and trainers, we have adapted some of the elements of the dog agility circuits to the urban environment, while also proposing a basic guide to the layout of such spaces for optimal shared leisureed activity: a fenced area; double door access to prevent dogs from running out when a new visitor comes into the area; including a water fountain; providing bag dispensers for excrements; adding benches for pet owners, etc... Spending leisure time with pets is a new social trend, and the design of this type of space fosters civic tolerance: we can all share public spaces if we foster respect and security.

FR

Les villes sont des entités dynamiques et ceux qui y agissent doivent toujours être attentifs aux nouvelles demandes de leurs habitants. Au cours des dernières années, le besoin de zones dédiées aux animaux s'est accru, pour permettre à leurs propriétaires de passer du temps avec eux.

Notre gamme Canes répond à ce nouveau style de vie selon un triple principe de bien-être : offrir des modules d'exercices adaptés aux animaux ; garantir une conception de parc répondant aux demandes des propriétaires ; délimiter correctement ces espaces. Car si nous défendons le contact avec la nature comme source de bien-être, ce contact doit toujours être volontaire.

Conseillés par des vétérinaires et experts du monde animal, nous avons adapté à l'environnement urbain certains éléments des circuits d'agilité, tout en proposant un guide de base pour la réalisation d'espaces de loisirs partagés: enceinte clôturée, entrée avec double porte pour empêcher les chiens de s'échapper quand arrive un nouveau visiteur, fontaines à eau, distributeurs de sacs pour déjections canines; des bancs pour les propriétaires des chiens ... Le loisir avec les animaux est une source de bien-être et la conception de ce type d'espace favorise la tolérance civique : nous pouvons tous partager les espaces publics en respectant les principes de respect et de sécurité.





CP01

25,6 m<sup>2</sup>
 269 x 12 cm
 50 cm
 -
 -



CP04

18,4 m<sup>2</sup>
 250 x 68 cm
 78 cm
 -
 -



CP02

21,6 m<sup>2</sup>
 313 x 83 cm
 50 cm
 -
 -



CP05

14,3 m<sup>2</sup>
 218 x 13 cm
 - cm
 -
 -



CP03

17,1 m<sup>2</sup>
 186 x 90 cm
 95 cm
 -
 -



CP06

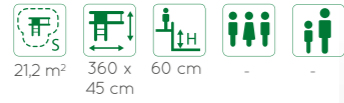

CP07

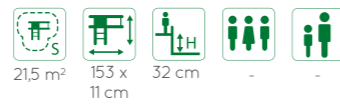

CP08

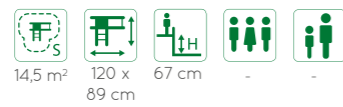

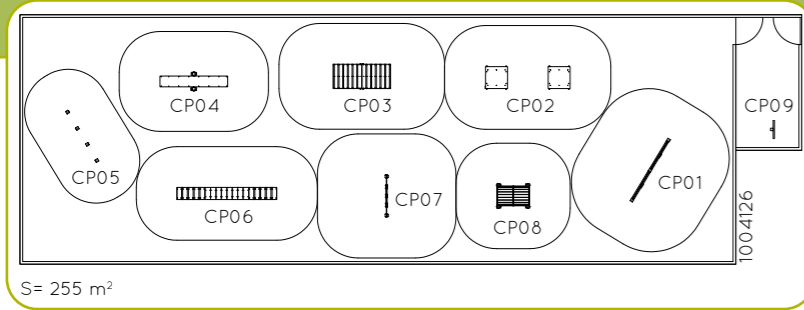

## O-A

50010	406	5000602	239	ARC09	388
50011	406	5000603	239	ARC12	388
50023	405	5000604	239	AS01	448
50025	404	5000701	240	AS02	448
50026	404	5000702	241	AS03	448
50027	408	5000703	241	ASBUBU	449
1002457	442	5000704	241		
1005256	442	A10	218		
1006216	442	A10-IN	430		
1006217	442	A30	362		
1006218	442	A40	364		
1006219	442	A50	364		
1006224	442	A100	364		
1006241	442	AF001	202		
1006242	442	AF001AL	202		
1009147	442	AF002	202		
5000101	238	AF002AL	202		
5000102	238	AF003	202		
5000103	238	AF003AL	202		
5000104	238	AF004	203		
5000201	238	AF004AL	203		
5000202	238	AF005	204		
5000203	238	AF005AL	204		
5000204	238	AF006	206		
5000301	238	AF006AL	206		
5000302	238	AF007	205		
5000303	238	AF007AL	205		
5000304	238	AQUA01	96		
5000401	239	ARC01	388		
5000402	239	ARC02	386		
5000403	239	ARC03	386		
5000404	239	ARC04	387		
5000501	239	ARC05	388		
5000502	239	ARC06	387		
5000503	239	ARC07	387		
5000504	239	ARC08	389		
5000601	239				

## B

B10KN	188
B20A	424
B21A_P	218
B30B-GM	218
B30B-GM_AL	218
B30B_P	421
B30B_PAL	421
B30C_P	421
B30E_P	422
B30E_PAL	422
B35A	426
B40B_P	422
B40B_PAL	422
B50A_P	423
B60A_P	423
B60Ai_P	423
B60D_P	423
B70A_P-2	164
B70A_P-c2	164
B80A_P	217
B90A_P	424
B90E	428
B100A_P	217
B101A	421
B102A	420
B102AI	420
B103A	424

B104A	421	C103-N	284	C214D_P	47	C307B-N	287	CDE22	509	CAMOPO-c2	460
B105A_P	217	C103_P	50	C214D_PAL	47	C307B-NT	302	CDE23	490	CP09	461
B106A_P	218	C103_PAL	50	C215D_P	47	C308B-N	287	CDE23M	478	CASEATCHA	461
B107A	164	C200A-N	284	C215D_PAL	47	C308B-NT	302	CDE24	556	CASEALU	460
B108A-c1	164	C201D_P	52	C216D_P	47	C400A-N	286	CDE25	557	CASEBA	461
B108A-c2	164	C201D_PAL	52	C216D_PAL	47	C400A-NT	302	CDE26	557	CASECUCHA	461
B109A	334	C202	213	C217D_P	55	C400D_P	46	CDE27	557	CASEFLE	463
B109B	334	C202AL	213	C217D_PAL	55	C400D_PAL	46	CDE28	558	CASELA	463
B110A_P	422	C203	212	C225	216	C602B-N	287	CDE30-O	564	CASELACAM	463
B110A_PAL	422	C203AL	212	C225AL	216	C602D_P	46	CDE30-R	564	CASELACRU	463
B120A	125	C204D_P	54	C226	216	C602D_PAL	46	CDE33	564	CASELAGI	463
B120A-c2	147	C204D_PAL	54	C226AL	216	CDE02	488	CDE35	558	CASEPI	462
B121A	125	C205	212	C301A-N	285	CDE02M	476	CDE36	558	CASIPICAM	462
B121A-c2	147	C205AL	212	C301B-N	284	CDE03	488	CDE37	560	CASEPICRU	462
B125A	188	C206	213	C301D_P	42	CDE03M	476	CDE38	560	CASEPIGI	462
B130A	431	C206AL	213	C301D_PAL	42	CDE04	488	CDE39	560	CASEPO	459
B140B	421	C206D_P	52	C302A-N	285	CDE04M	476	CDE40	561	CASETE	457
B140B_AL	421	C206D_PAL	52	C302A-NT	300	CDE05	488	CDE42	561	CASETEABI	457
B200A	314	C207	211	C302D_P	42	CDE05M	476	CDE50	491	CASETEABIDOBLE	457
B201A	314	C207AL	211	C302D_PAL	42	CDE06	489	CDE50M	478	CASETEPEABI	458
B202A	314	C208	211	C303A-N	285	CDE06M	477	CDE52	491	CASETESI-c1	459
B203A	314	C208AL	211	C303A-NT	300	CDE07	489	CDE52M	479	CASETESI-c2	459
B206A	314	C209	212	C303D_P	42	CDE07M	477	CDE53M	479	CASETEVI	458
B300A-c1	428	C209AL	212	C303D_PAL	42	CDE07T	489	CDE100A	491	CDE01_P	460
B300A-c2	428	C210	211	C304A-N	288	CDE07TM	477	CDE100AM	479	CDE14	50
BABUBU	449	C210AL	211	C304A-NT	300	CDE08	508	CDE200A	492	CDE14_AL	50
BU01	308	C210D_P	52	C304B-N	286	CDE09	490	CDE200AM	480	CDE32	398
BU03	80	C210D_PAL	52	C304B-NT	301	CDE10	508	CDE300A	492	CILIX	452
BU03AL	80	C211	213	C304D_P	44	CDE11	490	CDE300AM	480	CM01F01	247
BU04	310	C211AL	213	C304D_PAL	44	CDE12	508	CDE301AM	480	CM01F02	247
BU06	310	C211D_P	53	C304E_P	43	CDE13	490	CDE500AM	481	CM01F03	247
		C211D_PAL	53	C304E_PAL	43	CDE13M	478	CDE600AM	481	CM01F04	247
		C212D_P	53	C304F-NT	301	CDE15	503	CDE800AM	482	CM02F01	247
		C212D_PAL	53	C304F_P	43	CDE16	556	CDE700AM	484	CM02F02	247
C101-N	284	C213D_P	53	C304F_PAL	43	CDE18	556	CAMEIN	459	CM02F03	247
C101_P	50	C213D_PAL	53	C306B-N	286	CDE19	503	CAMOPO-c1	460	CM02F04	247
C101_PAL	50										

CM03F01	242
CM03F02	242
CM03F03	242
CM03F04	242
CM05F01	242
CM05F02	242
CM05F03	242
CM05F04	242
CM06F01	242
CM06F02	242
CM06F03	242
CM06F04	242
CM07F01	243
CM07F02	243
CM07F03	243
CM07F04	243
CM08F01	243
CM08F02	243
CM08F03	243
CM08F04	243
CM09F01	246
CM09F02	246
CM09F03	246
CM09F04	246
CM10F01	455
CM10F02	455
CM10F03	455
CM10F04	455
CM11F01	455
CM11F02	455
CM11F03	455
CM11F04	455
CM12F01	455
CM12F02	455
CM12F03	455
CM12F04	455

CM13F01	246
CM13F02	246
CM13F03	246
CM13F04	246
CM20F01	244
CM20F02	244
CM20F03	244
CM20F04	244
CM21F01	247
CM21F02	247
CM21F03	247
CM21F04	247
CM22F01	244
CM22F02	244
CM22F03	244
CM22F04	244
CM23F01	244
CM23F02	244
CM23F03	244
CM23F04	244
CM24F01	245
CM24F02	245
CM24F03	245
CM24F04	245
CM26F01	246
CM26F02	246
CM26F03	246
CM26F04	246
CM27F01	245
CM27F02	245
CM27F03	245
CM27F04	245
CP01	576
CP02	576
CP03	576
CP04	577

CP05	577
CP06	578
CP07	578
CP08	578
CP12	470
CT002_P	56
CT002_PAL	56
CT003_P	56
CT003_PAL	56
CT004_P	56
CT004_PAL	56
CT005_P	57
CT005_PAL	57
CT006_P	58
CT006_PAL	58
CT007_P	58
CT007_PAL	58
CT008_P	58
CT008_PAL	58
CUB010	124
CUB020	124
CUB030	124

## D

DEM01	140
DEM02	140
DEM03	141
DEM04	141
DEM05	142
DEM06	143
DEM07	144
DEM10	146
DEM11	146
DF001	208
DF001AL	208
DF002	208

DF002AL	208
DF003	208
DF003AL	208
DF004	209
DF004AL	209
DF005	209
DF005AL	209
DF006	209
DF006AL	209
DF007	210
DF007AL	210
DF008	210
DF008AL	210
DF009	210
DF009AL	210
DOMO3	374
DOMO4	373
DOMO5	372
DX003M-c1	156
DX003M-c2	156
DX101M-c1	156
DX101M-c2	156
DX102M-c1	156
DX102M-c2	156
DX103M-c1	157
DX103M-c2	157
DX201M-c1	157
DX201M-c2	157
DX202M-c1	157
DX202M-c2	157
DX203M-c1	160
DX203M-c2	160
DX204M-c1	160
DX204M-c2	160
DX205M-c1	158
DX205M-c2	158

DX201M-c1	161
DX201M-c2	161
DX206M-c1	161
DX206M-c2	161
DX207M-c1	161
DX207M-c2	161

## E

EP00-R	324
EP01	326
EP01-R	326
EP01-RR	326
EP02	326
EP02-R	326
EP04	326
EP04-R	326
EP04-RR	326
EP06	327
EP06-R	327
EP06-RR	327
EP07	327
EP07-R	327
EP07-RR	327
EP09	327
EP09-R	327
EP09-RR	327
EP12	328
EP13	328
EP14	328
EP15	329
EP16	329

## F

F100A	97
F100B	98
F100C	98

F100D	98
F100E	98
F100G	99
F101A_P	453
F201A_P	453
F201B_P	453
F202A_P	454
F304A_P	72
F305_P	74
F305_PAL	74
F305A_P	76
F305A_PAL	76
F306A_P	72
F307A_PAL	72
F307D_P	55
F307D_PAL	55
F307-N	293
F308D_P	54
F308D_PAL	54
F309-N	293
F309_P	72
F309_PAL	72
F310	97
F311_P	73
F311_PAL	73
F312	216
F312AL	216
F313	454
F313E	146
F400A_P	74
F400A_PAL	74
F400A-A_P	78
F400A-A_PAL	78
F400B_P	75
F400B_PAL	75
F400C_P	75



F400C_PAL	75
F401_P	71
F401_P-c5	71
F402_P	71
F402_PAL	71
F403_P	74
F403_PAL	74
F404A_P	76
F404A_PAL	76
F405A_P	76
F405A_PAL	76
F407_PAL	71
F500	99
F502_P	79
F502_PAL	79
F503_P	79
F503_PAL	79
F504	79
F504AL	79
F600	312
F601	312
F602	312
F603	312
F604	313
F705Ai_P	78
F705Ai_PAL	78
F805Ai_P	78
F805Ai_PAL	78
FAC02-c1	410
FAC02-c2	410
FAC03-c1	410
FAC03-c2	410
FAC04	410
FAC05	412
FAC06	412
FAC07	412

FAC08T	414
FAC09T	414
FAC10	254
FAC12	414
FAC13	415
FAC14	415
FAC15	415
FAC16	254
FAC17	254
FAC19	416
FAC20	416
FAC21	416
FAC22	418
FAC23T_P	418
FAC24	418
FAC25	258
FAC26	419
FAC27GDRT	262
FAC27RT	260
FAC28GDRT	266
FAC28RT	264
FAC29GDRT	270
FAC29RT	268
FAC30GDRT	274
FAC30RT	272
FAC100	419
FAC100AL	419
FAC0225	258
FAC0225M	258
FAC0225G	259
FAC0230GRT	273
FAC0230MRT	272
FAC0230RT	272
FAC1016	255
FAC1017	255
FAC1237GRT	261

FAC1237MRT	260
FAC1327RT	260
FAC1429GRT	269
FAC1429MRT	268
FAC1429RT	268
FAC101617	256
FAC2628GRT	265
FAC2628MRT	264
FAC2628RT	264
FAC041017	255
FONDSTD	570
FORT_GAL	306
FP01E-c1	342
FP01E-c2	342
FP01ERT-004	342
FP02E-c1	342
FP02E-c2	342
FP02ERT-004	342
FP03E-c1	342
FP03E-c2	342
FP03ERT-004	342
FP04E-c1	343
FP04E-c2	343
FP04ERT-004	343
FP05E-c1	343
FP05E-c2	343
FP05ERT-004	343
FP06E-c1	343
FP06E-c2	343
FP06ERT-004	343
FP07E-c1	344
FP07E-c2	344
FP07E-c2-c5_1	344
FP08E	344
FP08E-c5_1	344
FP09E-c1	348

FP09E-c2	348
FP09ERT-004	348
FP10E-c1	344
FP10E-c2	344
FP10ERT-004	344
FP11E-c1	346
FP11-c2	346
FP11ERT-004	346
FR01	178
FR02	178
FR03	180
FR04	178
FR05	179
FR06	179
FR07	179
FR08	188
FR100A	496
FR100B	194
FR101A	596
FR101B	195
FR102A	496
FR102B	195
FR103A	496
FR103B	195
FR104A	497
FR104B	196
FR105A	497
F105B	195
FR106A	497
FR106B	194
FR107A	497
FR107B	194
FR108A	497
FR108B	196
FR109A	497
FR109B	196

FR110A	497
FR110B	197
FR111A	497
FR111B	197
FR112A	497
FR112B	197
FR113A	497
FR113B	194

**G**

GA01	516
GA02	516
GA03	516
GA04	517
GA06	517
GA07	517
GA08	518
GA09	518
GA10	518
GA11	519
GA12	519
GC01	512
GC02	512
GC04	512
GC09M	485

**H-J**

JJ002NT	303
JJ003	60
JJ003AL	60
JJ004NT	303
JJ005	60
JJ005AL	60
JJ006-NT	304
JJ007	68
JJ007AL	68

JJ009	61
JJ009AL	61
JJ011	59
JJ011AL	59
JJ013	61
JJ013AL	61
JJ015	62
JJ015AL	62
JJ017	64
JJ017AL	64
JJ019	66
JJ019AL	66
JSA012	538
JSA012R	526
JSA013	538
JSA013R	526
JSA014	538
JSA014R	526
JSA015	539
JSA016	539
JSA017	539
JSA017R	527
JSA018	540
JSA019	540
JSA024	540
JSA024R	527
JSA027	542
JSA027R	528
JSA028	542
JSA028R	527
JSA029	542
JSA029R	528
JSA030	543
JSA030R	528
JSA031	543
JSA031R	529

JSA032	543
JSA032R	529
JSA044R	529
JSA045	544

**K**

K010N	502
K020	502
K022N	182
K030N	502
K031N	183
K032	182
K040N	503
K042N	184
K050N	503
K051N	183
K052N	186
K060N	503
K061N	186
K070N	504
K080N	504
K091N	183
K092N	187
K093N	187
K-ROC1L-01	230
K-ROC1L-02	230
K-ROC1S-01	230
K-ROC1S-02	230
K-ROC2L-01	231
K-ROC2L-02	231
K-ROC2S-01	231
K-ROC2S-02	231
K-ROC3L-01	233
K-ROC3L-02	233
K-ROC3S-01	232
K-ROC03-02	232

**L**

L15	150
L15C	150
L16	150
L16C	150
L17	366
L18	367
L19	444
L21	398
L23	149
L24-c1	166
L24-c2	166
L25	398
L31	382
L32	392
L33	148
L34	190
L35	191
L36	126
L36N	190
L37	127
L37N	191
L38	148
L39	149
L41	399
L50	399
L70	399
L75	400
L80	400
L82i	400
L85i	401
L90	401
L610	336
L611	337

**M**

MET36	100
MC001	449
MEBUBU	450
MEBUBUSE	450
ML100	401
ML110	401
ML902	402
ML903	402
ML904	402
MOLAQUA	96
MU005	510

**O-P**

ONDCER	451
ONDCOR	450
ONDLAR	451
PAC002	104
PAC002_AL	104
PAC003	104
PAC003_AL	104
PAC004	104
PAC004_AL	104
PAC006	105
PAC006_AL	105
PAC012	105
PAC012AL	105
PAC013	105
PAC013_AL	105
PAC014	105
PAC014_AL	105
PAC015	105
PAC015_AL	105
PAC022	106
PAC023	106

PAC024	107
PAC025	107
PAC026	107
PAC027	108
PAC028	108
PAC029	109
PAC030	109
PAC031	109
PAC032	110
PAC033	110
PAC034	110
PAC035	112
PAC036	112
PAC037	113
PAC038	113
PAC039	113
PAC040	114
PAC041	114
PAC042	118
PAC043	119
PAC044	119
PAC045	119
PAC046	114
PAC047	115
PAC048	115
PAC049	115
PAC050	116
PAC051	116
PAC052	106
PAC053	116
PAC054	117
PAS01	330
PAS02	330
PASTOB	389
PEZ01	419
PEZ02	70

PEZ03	70
PEZ04	70
PEZ04AL	70
PEZ06	70
PEZ06AL	70
PEZ07	71
PEZ07AL	71
PEZ08-N	313
PEZ09-N	313
PEZ10	75
PEZ10AL	75
PEZ11	454
PIRATRUN	313
PIRHEX	381
PISTALTD	566
PISTASTD	568
PLA001	217
PLA002	217
PLA003	426
PLA004	217
PLA009	428
POS01	117
POS02	117
POS03	118
PUZZ	99
PV15	469

**R**

R04	377
R04D	376
R06	379
R06D	378
R2	386
R2,75	381
R2,75S	381
R31	382

RA02	97
REDFPAR	330
REDFPAR-R	330
REDTRI	331
REDVER	331
RELIX	452
RM01A	390
RM01B	390
RM01C	391
RM01D	391
RNT01	385
RNT01F	385
RN02	385
ROCO	565
ROT500	438
ROT600	438
ROT900	438
ROT1000	438
ROT1000-2D	439
ROT1000-2I	439
ROT1300	438
ROT1400	438
ROT1400-3D	439
ROT1400-3D	439
ROT1700	438
ROT1800	438
ROT1800-2D4I	440
ROT18002I4D	440
ROT2100	438
ROT2200	438
ROT2200-3D5I	440
ROT2200-3I5D	440
ROT2500	438
ROT2500-3D5I	440
ROT2500-3I5D	440
ROT3000-3D6I	440

ROT3000-3I6D	440
ROT3400-3D6I	440
ROT3400-3I6D	440
ROT3800-4D7I	440
ROT3800-4I7D	440
ROT4200-4D8I	440
ROT4200-4I8D	440
RP03	384
RSPIDER	382
RT03	384
RT03D	384

## S-T

SADDLE	380
SADTO	380
SIBUBU	449
T10A_P	82
T10A_PM	82
T10B_P	82
T10B_PM	82
T10C	82
T10M	82
T10D_P	83
T10D_PM	83
T11_P	83
T11_PAL	83
T12_P	219
T13	219
T13_AL	219
T15	348
T15E	348
T16	349
T16E	349
T18	85
T18_AL	85
T20A-N	290

T20B-N	290
T20D_P	51
T20D_PAL	51
T30A-N	290
T30B-N	291
T30D_P	51
T30D_PAL	51
T30Z-N	293
T31C	84
T31C_AL	84
T40A-N	291
T40B-N	291
T40D_P	51
T40D_PAL	51
T41C	84
T41C_AL	84
T50_P	83
T60A-N	292
T70F	219
T70F_AL	219
T71C_P	84
T71C_PAL	84
T1400A	434
T1400AB	434
TAMB05	102
TGM1	432
TGM1-N	316
TGM2	432
TGM2-N	316
TGM3	432
TGM3-N	316
TGM4	432
TGM4-N	316
TGM5	432
TGM5-N	316
TIC	437

TIC_DE	437
TIC_IZ	437
TLF_5M	103
TLF_5MR	103
TOB01	444
TOBREC	434
TOMA	294
TOMA-1T	295
TOMOL-1T	298
TORARQ	96
TORRED-1T	296
TOT01	333
TP01	71
TP01AL	71
TR100	408
TTI_3,25	436
TTI_DE	436
TTI_IZ	436
TUB100	134
TUB200	375
TUB300	132
TUB400	132
TUB500	133
TUB600	133
TUB-TLF	133
TW001	544
TW001R	530

## U

U10A_P	423
U20A_P	424
U30A_P	426
U30Ai_P	426
U40A_P	423
U50A_P	420
U60A_P	420

U60Ai_P	420
U80A_P	420
U90A	426
U100A_P-c1	218
U100A_P-c2	422
U100A_PAL-c1	218
U100A_PAL-c2	422
U120Ai	424
U130Ai	424
UG010	510
UG010M	534
UG020	511
UG020M	534
UG030	522
UG030M	
UG040	511
UG040M	
UG050	522
UG050M	536
UG060	524
UG060M	
UG070	523
UG070M	
UG080	523
UG080M	534
UG110	548
UG110T	548
UG111	548
UG210	548
UG210T	548
UG211	550
UG310	549
UG310T	549
UG311	549
UG410	553
UG410T	553
UG510	549
UG510T	549
UG610	554

UG610T	554
UG710	554
UG710T	554
UG810	555
UG810D	555
UG810R	530
UG910	545
UG910R	530
UG1010	545

## V-Z

V01C_P	466
V01C_P_O	466
V02	466
V02-N	467
V02-O	467
V02-T	467
V03-N	464
V03_P	464
V06-N_P	465
V06_P	465
V08	468
V08-G	468
V09	469
V11	470
V15	469
VAM01	102
VIEQ	331
VT01	332
VT02	332
VT03	332
VT04	333
VT05	333
VT07	334
VT08	334
XIL	100
XIL26	100



**Altura Crítica de Caída**  
Critical Fall Height  
Hauteur de Chute Critique



**Número de Usuarios**  
Number of Users  
Nombre D'utilisateurs



**Edades de Uso Recomendadas**  
Recommended Ages  
Âge recommandé D'utilisation



**Superficie del Área de Seguridad**  
Safety Area Surface  
Surface de la Zone de Sécurité



**Dimensiones del elemento**  
Element Dimensions  
Dimensions de l'élément

\* La información técnica contenida en el presente catálogo es de carácter general y tiene una finalidad meramente informativa.  
\* The technical information contained in this catalog is of a general nature and is for informational purposes only.  
\* Les informations techniques contenues dans ce catalogue sont de nature générale et à titre informatif uniquement.



**Universal**  
Universal  
Universel



**Atravesar**  
Go through  
Traverser



**Balancearse**  
Swivel  
Se balancer



**Colgarse**  
Hang  
Se suspendre



**Deslizarse tirolesa**  
Slide zip line  
Glisser tyrolienne



**Columpiarse**  
Swing  
Se balancer



**Deslizarse barra**  
Slide Bar  
Barre de glisse



**Deslizarse**  
Slide  
Glisser



**Equilibrio**  
Balance  
Équilibre



**Rebotar**  
Bounce  
Rebondir



**Gatear**  
Crawl  
Rampier



**Girar**  
Rotate  
Rotation



**Manipular**  
Handling  
Manipuler



**Reunión**  
Meeting  
Réunion



**Juego de roles**  
Roles  
Jeux de rôles



**Saltar**  
Jump  
Sauter



**Trepar**  
Climb  
Grimper



**Equilibrio**  
Balance  
Équilibre



**Detenerse**  
Stop  
Arrêter



**Trepar**  
Climb  
Grimper



**Atravesar**  
Go through  
Traverser



**Saltar**  
Jump  
Sauter



**Saltar a través**  
Jump through  
Sauter à travers



**Slalom**  
Slalom  
Slalom



**Atravesar**  
Go through  
Traverser



[www.galopinplaygrounds.com](http://www.galopinplaygrounds.com)

SÍGUENOS EN / FOLLOW US ON / SUIVEZ-NOUS SUR



PRODUCT 100%  
MADE IN THE EU